

# LEARNING to READ

## Word Families



*Educational Worksheets*



# LEARNING to READ

## Word Families



**Learning to Read ~ Word Families**

written by Louise and Greg Porich

© Burrabooks Pty Ltd.

First Published 2004

Reprinted 2005

Revised and Reprinted 2007

ABN 22 070 006 085

P. O. Box 611,

Moruya NSW 2537

Ph: 0244 742 355

Fax: 0244 742 399

All rights reserved.

Except under the conditions described in the Copyright Act, 1968 of Australia and subsequent amendments, no part of this publication may be reproduced, stored in a retrieval system or transmitted in any form or by any means, electronic, mechanical, photocopying, recording, scanning or otherwise without the express prior permission of the copyright owner.

As with all Burrabooks publications every attempt is made to acknowledge copyright. Any infringements are purely coincidental and the publisher offers apologies where applicable.

ISBN 13: 978-1-86402-007-6

ISBN 10: 1-86402-007-5

**www.burrabooks.com.au**  
**mail@burrabooks.com.au**  
Latest books, news & more.



**BURRABOOKS**

www.burrabooks.com.au

mail@burrabooks.com.au

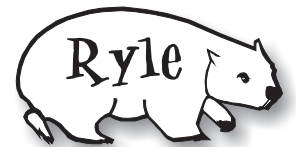

**BUR-203**

ISBN 13: 978-1-86402-007-6  
ISBN 10: 1-86402-007-5



9 781864 020076

**BUR-203**

# LEARNING TO READ

## Word Families















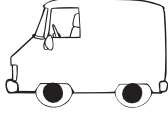



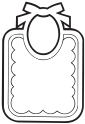

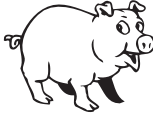





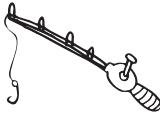

### Introduction

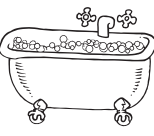
‘Learning to Read ~ Word Families’ has been designed to help students recognise word families and to help them blend three-letter words.

All words in the families contain the same middle and final sounds (vowel-consonant).

The activities will help students to recognise patterns within words and to blend sounds together to make words.

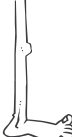
The pictures below are examples of the word families treated in this book.

 <b>cab</b>	 <b>dad</b>	 <b>bag</b>	 <b>ham</b>	 <b>van</b>	 <b>tap</b>
 <b>cat</b>	 <b>fax</b>	 <b>bib</b>	 <b>lid</b>	 <b>pig</b>	 <b>Tim</b>
 <b>fin</b>	 <b>lip</b>	 <b>sit</b>	 <b>sob</b>	 <b>rod</b>	 <b>dog</b>
 <b>top</b>	 <b>cot</b>	 <b>tub</b>	 <b>mug</b>	 <b>mum</b>	 <b>sun</b>
 <b>hut</b>	 <b>bed</b>	 <b>leg</b>	 <b>hen</b>	 <b>jet</b>	

# cab



Use these letters to make ab words.

l n t c d j

.....ab                      .....ab

.....ab                      .....ab

.....ab                      .....ab

Trace the correct sentence.

A slab is on a cab.

A crab is on a cab.

I stab the cab.



Write the sentence here.

.....  
.....

Colour the ab words in the word puzzle.



kebab

n	a	b	s	o
c	r	a	b	m
n	d	c	l	j
q	m	a	a	a
s	t	a	b	b

tab

cab

dab

jab

lab

nab

stab

crab

Use these letters to make ad words.

b h p f m s

.....ad .....ad  
.....ad .....ad  
.....ad .....ad

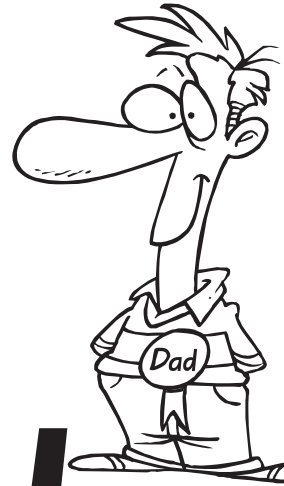

**d**ad

Trace the correct sentence.



Dad is sad.

Mum had a pad.

The lad is mad.

Write the sentence here.

.....  
.....

Colour the ad words in the word puzzle.

m	l	b	l	q
g	s	a	d	m
l	p	d	d	a
a	t	a	a	d
d	h	a	d	q

had bad

pad sad

dad mad

lad glad



Use these letters to make ag words.

wag

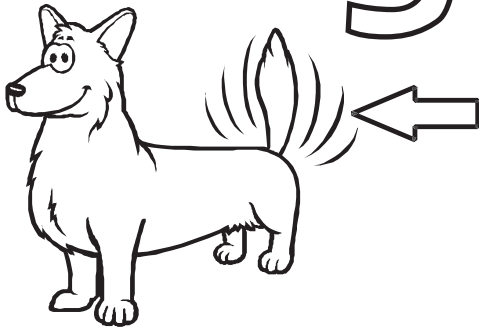

w j b s n r

.....ag .....ag

.....ag .....ag

.....ag .....ag

Trace the correct sentence.

A bag with a flag.

Mum with a bag.

The bag has a tag.



Write the sentence here.

.....  
.....

Colour the ag words in the word puzzle.

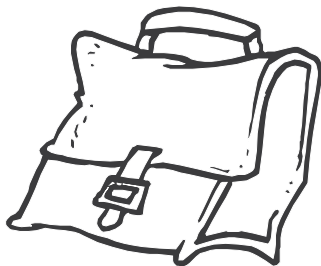

bag

s	n	a	g	e
n	f	r	u	w
a	l	t	a	a
g	a	b	a	g
p	g	s	a	g

bag

sag

rag

flag

wag

snag

tag

nag

Use these letters to make am words.

S j h d y r

.....am .....am

.....am .....am

.....am .....am

ham

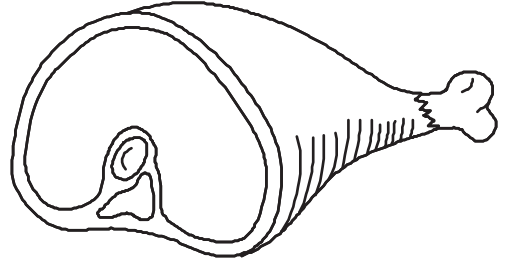

Trace the correct sentence.



Sam has some jam.

Sam has a yam.

Sam has a ham.

Write the sentence here.

.....  
.....

Colour the am words in the word puzzle.

s	d	P	a	m
S	a	m	w	r
h	m	r	y	j
a	w	u	a	a
m	z	y	a	m

ram Sam

yam ham

dam jam

Pam

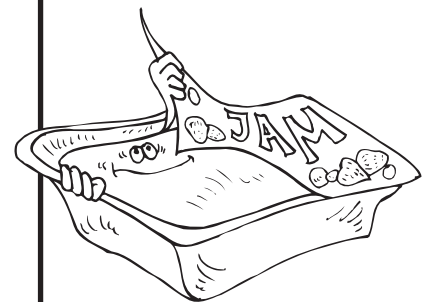

jam



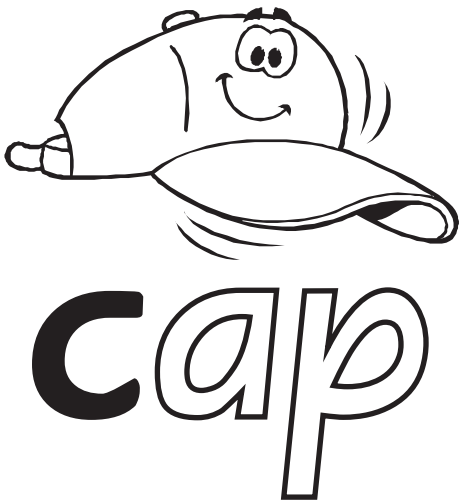

Use these letters to make ap words.

c s l t r m

.....ap .....ap  
.....ap .....ap  
.....ap .....ap

Trace the correct sentence.

A map on a cap.  
A cap on a map.  
A tap on a cap.



Write the sentence here.

.....  
.....

Colour the ap words in the word puzzle.



nap

i	t	a	p	m
f	i	g	l	a
r	s	r	a	p
q	c	a	p	p
c	n	a	p	i

tap map  
rap gap  
lap cap  
sap nap

Use these letters to make an words.

c p m r t f

.....an

.....an

.....an

.....an

.....an

.....an

**Van**

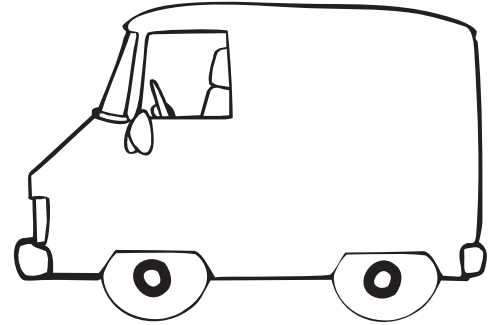

Trace the correct sentence.

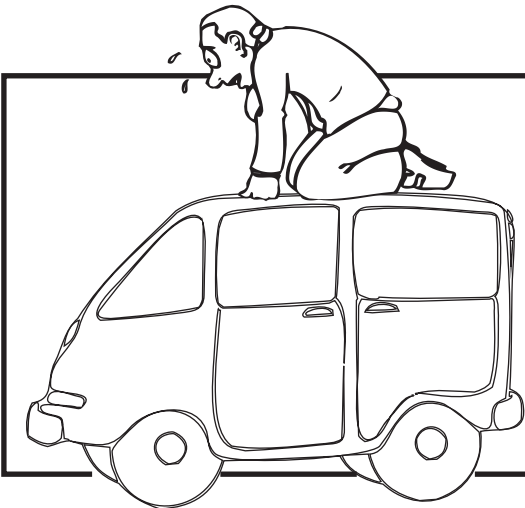

A man on a van.

A fan on a van.

A pan on a van.

Write the sentence here.

.....  
.....

Colour the an words in the word puzzle.

g	r	t	c	m
i	e	c	p	a
j	b	r	a	n
i	u	a	n	n
s	t	a	n	c

ran fan  
 pan can  
 man ban  
 van tan

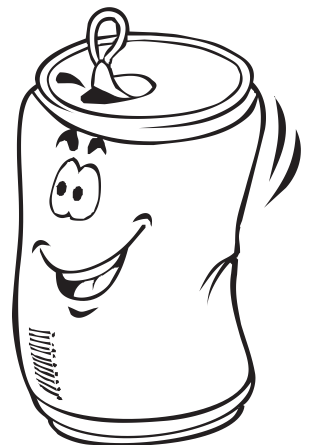

can

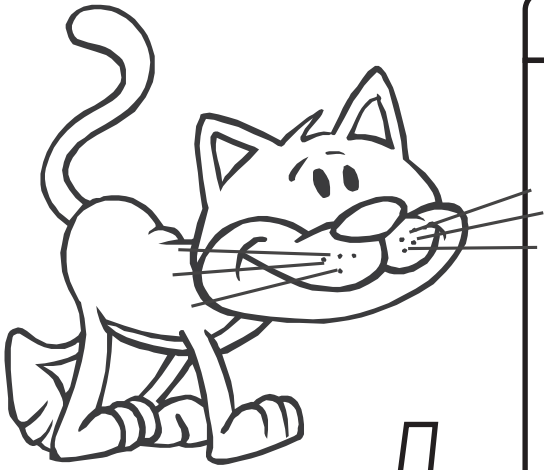

cat

Use these letters to make at words.

r c m f b s

.....at .....at

.....at .....at

.....at .....at

Trace the correct sentence.

A rat on a cat.

A hat on a cat.

A mat on a cat.



Write the sentence here.

.....  
.....

Colour the at words in the word puzzle.



rat

b	a	t	m	s
p	m	c	a	t
d	a	h	t	f
r	a	t	a	a
b	t	s	a	t

sat bat  
 hat pat  
 fat mat  
 rat cat

Use these letters to make ax words.

t M l s w f

.....ax .....ax

.....ax .....ax

.....ax .....ax

fax



Trace the correct sentence.



Max has a fax.

Max waxes the fax.

Max has a sax.

Write the sentence here.

.....  
.....

Colour the ax words in the word puzzle.

w	M	s	c	u
f	w	a	x	f
t	a	x	x	j
b	e	x	w	n
l	h	u	h	w

wax fax

Max lax

sax tax



sax



**bib**

Use these letters to make **ib** words.

r b n f j

.....**ib**

.....**ib**

.....**ib**

.....**ib**

.....**ib**

Trace the correct sentence.

The nib is on the bib.

The rib is on the bib.

The nib is on the rib.



Write the sentence here.

.....  
.....

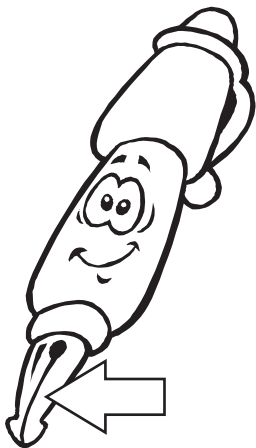

**nib**

Colour the **ib** words in the word puzzle.

j	n	f	i	b
d	i	b	s	i
n	i	b	r	b
k	n	t	i	o
g	n	o	b	x

**fib**

**bib**

**nib**

**dibs**

**jib**

**rib**

Use these letters to make id words.

d k h r l b

.....id      .....id  
.....id      .....id  
.....id      .....id

lid

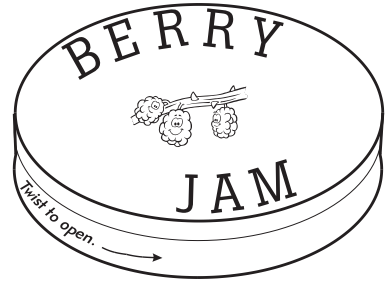

Trace the correct sentence.

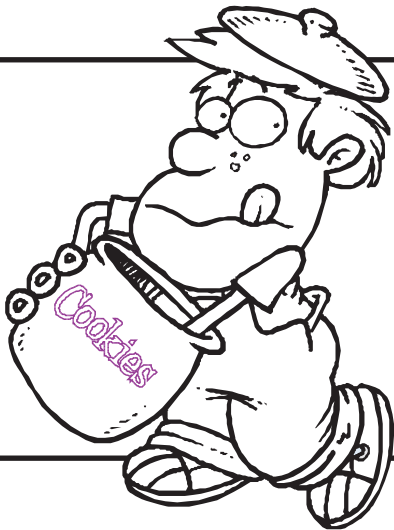

The kid hid the lid.  
The lid is on the kid.  
Dad hid the lid.

Write the sentence here.

.....  
.....

Colour the id words in the word puzzle.

k	t	k	h	j
z	d	r	i	d
S	l	i	d	d
i	b	i	d	i
d	m	i	d	e

rid      did  
kid      bid  
hid      Sid  
lid      mid



kid

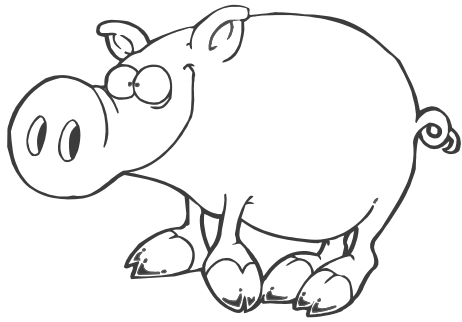

**pig**

Use these letters to make ig words.

b f d w r j

.....ig                      .....ig

.....ig                      .....ig

.....ig                      .....ig

Trace the correct sentence.

The fig has a big wig.

The pig has a big fig.

The pig has a big wig.

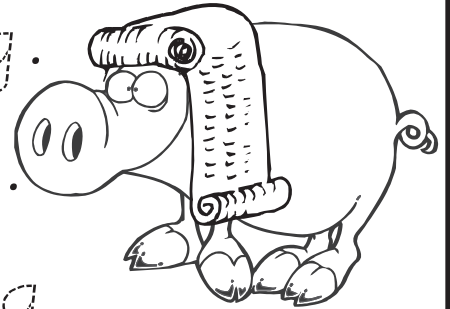

Write the sentence here.

.....  
.....

Colour the ig words in the word puzzle.



**dig**

v	r	d	w	f
f	p	i	i	i
m	j	i	g	g
s	b	i	g	i
g	r	i	p	g

**jig**

**fig**

**rig**

**pig**

**wig**

**big**

**dig**

**gig**

Use these letters to make im words.

r d h T K J

.....im .....im

.....im .....im

.....im .....im

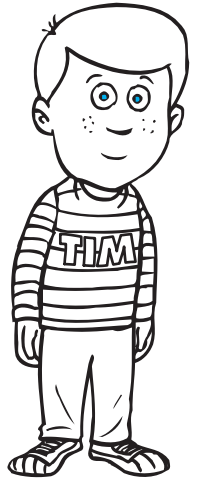

Tim

Trace the correct sentence.

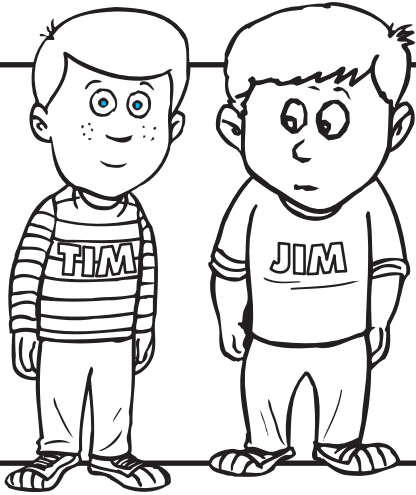

Kim sees Tim.

Kim went with him.

Jim sees Tim.

Write the sentence here.

.....  
.....

Colour the im words in the word puzzle.

q	c	d	r	x
q	K	T	i	m
b	h	i	m	m
f	J	i	m	u
p	q	d	d	k

Tim him

dim Kim

rim Jim

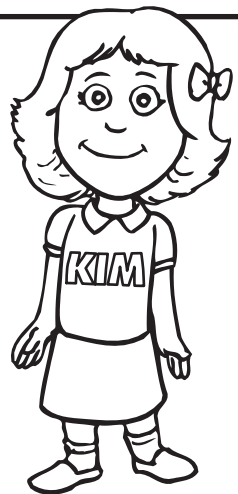

Kim



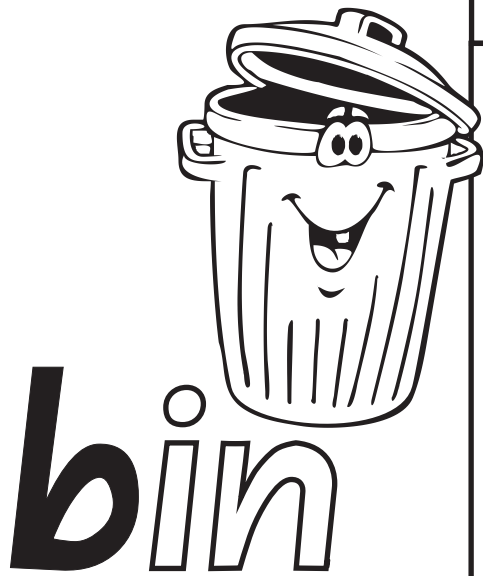

Use these letters to make in words.

w d f t p b

.....in                      .....in

.....in                      .....in

.....in                      .....in

Trace the correct sentence.

The pins are on the fin.

The pins are on the tin.

The tins are on the pin.

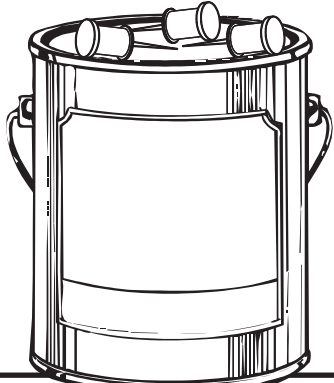

Write the sentence here.

.....

.....

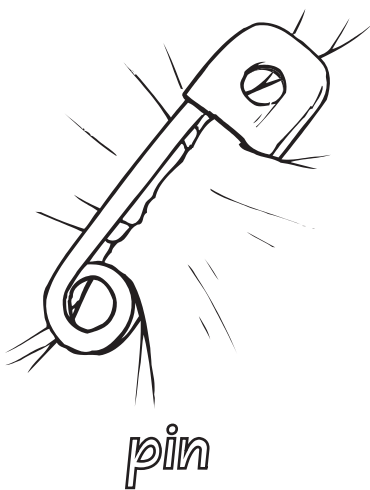

Colour the in words in the word puzzle.

t	b	i	n	t
k	i	n	p	n
f	i	n	i	s
w	d	i	n	i
k	x	w	i	n

kin            din

tin            sin

fin            win

pin            bin

Use these letters to make ip words.

s t d r h n

.....ip

.....ip

.....ip

.....ip

.....ip

.....ip

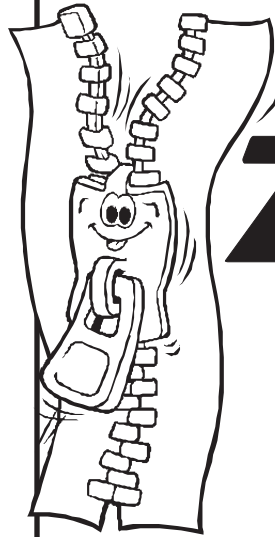

zip

Trace the correct sentence.



I zip my lip.

I trip on my lip.

I sip with my lip.

Write the sentence here.

.....  
.....

Colour the ip words in the word puzzle.

s	i	p	r	x
h	l	n	i	p
i	b	l	p	t
p	i	p	i	i
h	m	d	i	p

dip

rip

lip

sip

tip

hip

nip

pip

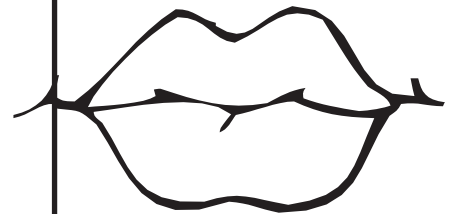

lips

# hit



Use these letters to make it words.

b s l f k p

.....it                      .....it

.....it                      .....it

.....it                      .....it

Trace the correct sentence.

The dog sits in the pit.

He sits in the pit.

The cat sits in the pit.



Write the sentence here.

.....  
.....

Colour the it words in the word puzzle.



l	i	t	u	i
n	i	t	b	h
f	u	s	b	i
i	r	w	i	t
t	k	i	t	t

wit

kit

hit

fit

sit

lit

bit

nit

Use these letters to make ob words.

c r s m j l

.....ob .....ob  
.....ob .....ob  
.....ob .....ob

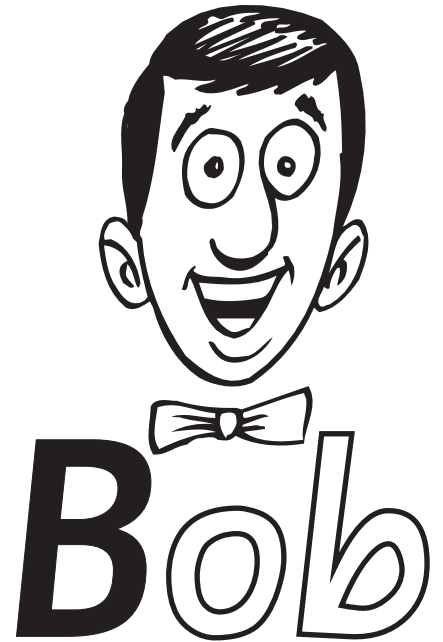

Trace the correct sentence.



I saw a mob.  
I saw Bob sob.  
I did a job.

Write the sentence here.

.....  
.....

Colour the ob words in the word puzzle.

s	o	b	c	m
d	n	r	o	b
o	m	o	b	j
b	b	o	b	o
q	i	r	n	b

sob nob  
rob bob  
cob dob  
mob job

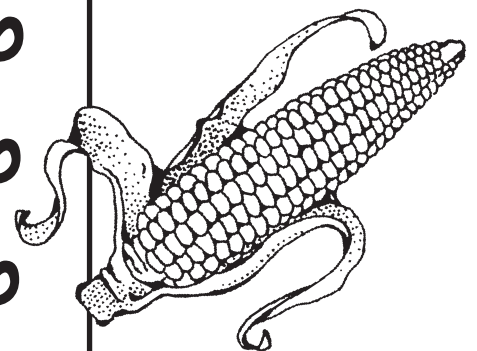

corn cob

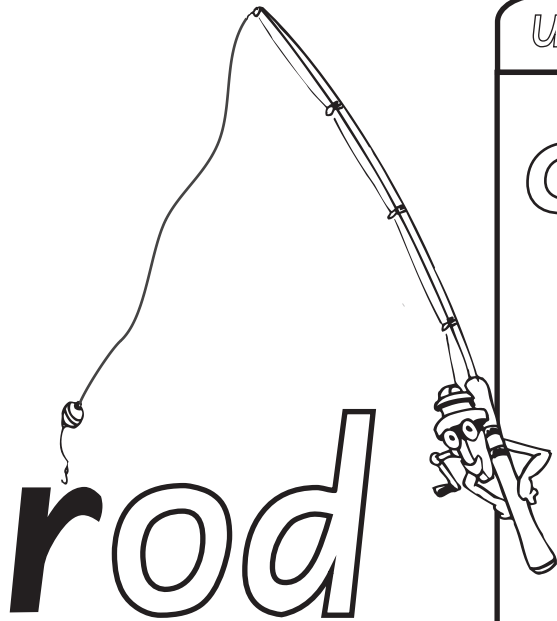

Use these letters to make od words.

c p r s n G

.....od .....od

.....od .....od

.....od .....od

Trace the correct sentence.

I saw Rod nod.

A cod on a rod.

A rod on a pod.

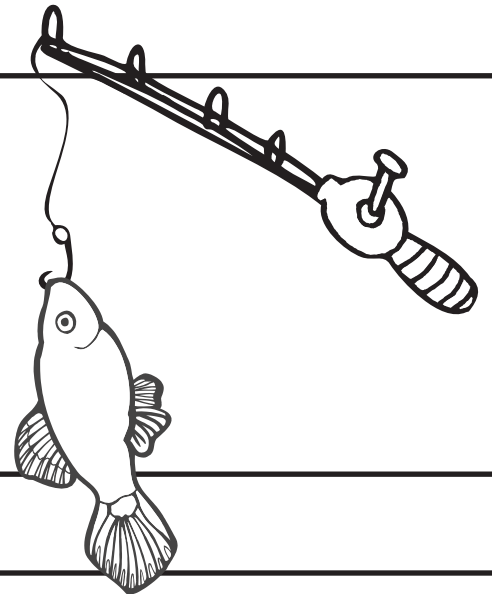

Write the sentence here.

.....  
 .....

Colour the od words in the word puzzle.

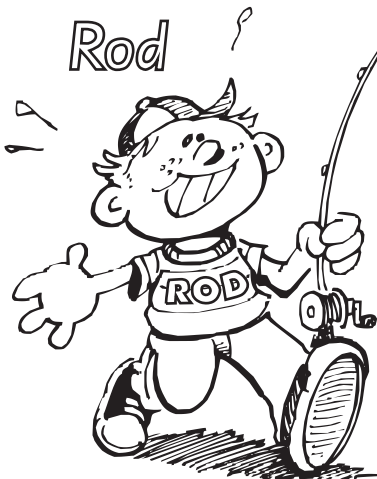

q	r	s	c	i
j	G	o	o	t
z	p	o	d	d
h	n	o	d	s
a	l	e	o	m

pod God

rod sod

cod nod

Use these letters to make og words.

h b d f c l

.....og .....og  
.....og .....og  
.....og .....og

dog



Trace the correct sentence.

The dog sits on a cog.  
The dog sits on a log.  
The dog is in the fog.

Write the sentence here.

.....  
.....

Colour the og words in the word puzzle.

j	k	c	b	b
q	d	l	o	o
h	d	f	o	g
o	o	j	o	g
g	g	e	t	q

fog jog  
cog hog  
bog dog  
log

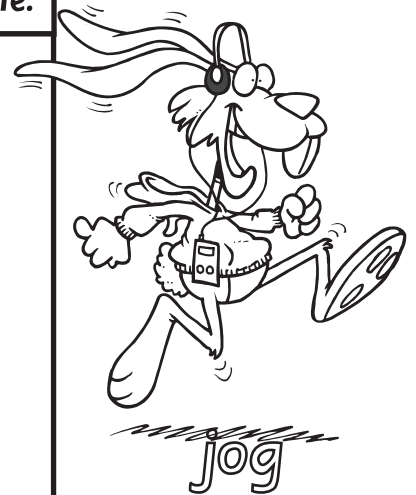

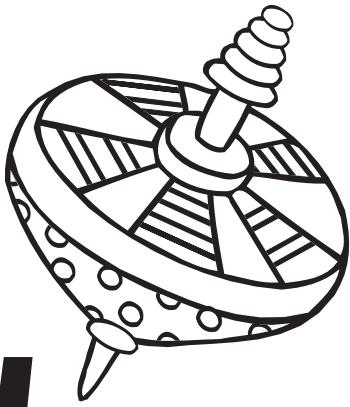

top

Use these letters to make op words.

p c m h l b

.....op .....op

.....op .....op

.....op .....op

Trace the correct sentence.

The mop has a top.

Pop has a mop.

Pop has a top.



Write the sentence here.

.....  
.....

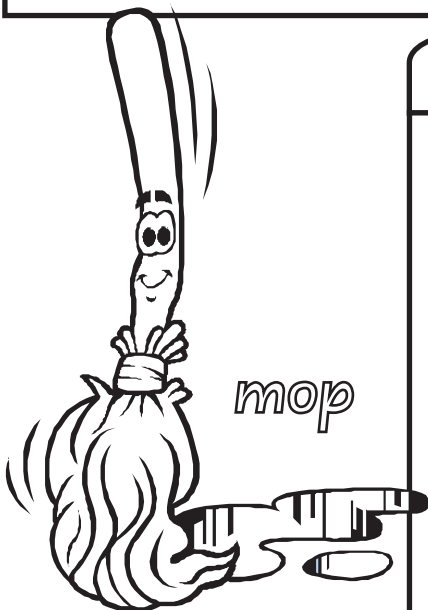

Colour the op words in the word puzzle.

z	t	m	d	b
s	o	p	m	o
c	p	h	o	p
o	l	o	p	p
p	m	n	i	r

hop sop

mop top

bop lop

pop cop

Use these letters to make ot words.

h n g p d r

.....ot .....ot  
.....ot .....ot  
.....ot .....ot

cot

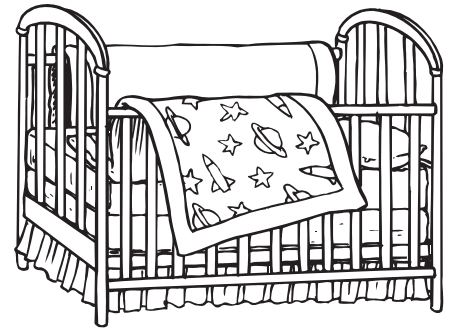

Trace the correct sentence.

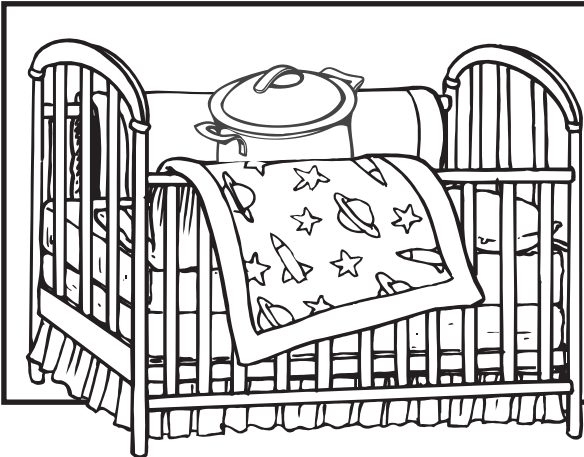

A pot in a cot.  
A dot on a pot.  
Dad got a pot.

Write the sentence here.

.....  
.....

Colour the ot words in the word puzzle.

u	q	y	p	c
t	c	r	l	o
d	n	g	o	t
o	p	o	t	t
t	h	o	t	z

got not  
cot hot  
lot rot  
pot dot



pot



# tub

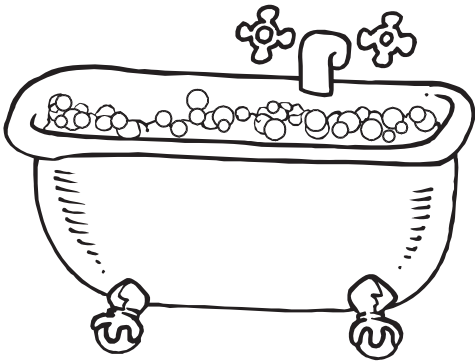

Use these letters to make ub words.

s c t h p b

.....ub .....ub  
.....ub .....ub  
.....ub .....ub

Trace the correct sentence.

A cub in a tub.

A sub in a tub.

A cub in a sub.

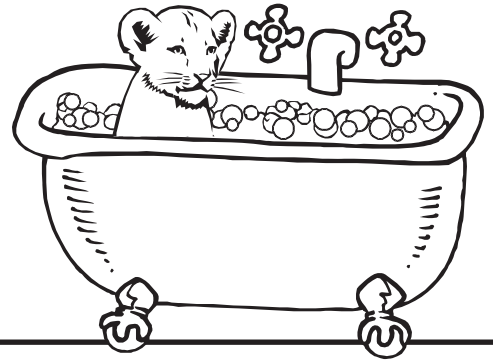

Write the sentence here.

.....  
.....

Colour the ub words in the word puzzle.

sub

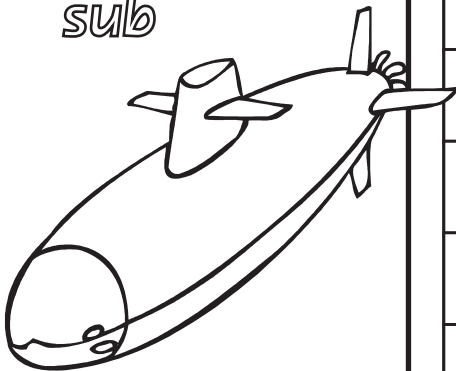

r	d	u	b	k
r	u	p	j	c
s	u	b	u	u
c	a	h	u	b
a	t	t	u	b

hub sub  
pub rub  
cub tub  
bub dub

Use these letters to make ug words.

r b h d m t

.....ug .....ug

.....ug .....ug

.....ug .....ug

jug



Trace the correct sentence.



A mug in a jug.

A rug in a mug.

A bug in a mug.

Write the sentence here.

.....  
.....

Colour the ug words in the word puzzle.

f	q	r	b	u
l	d	t	u	g
p	m	u	g	g
u	h	u	g	z
g	t	j	u	g

tug dug

rug hug

bug jug

mug pug

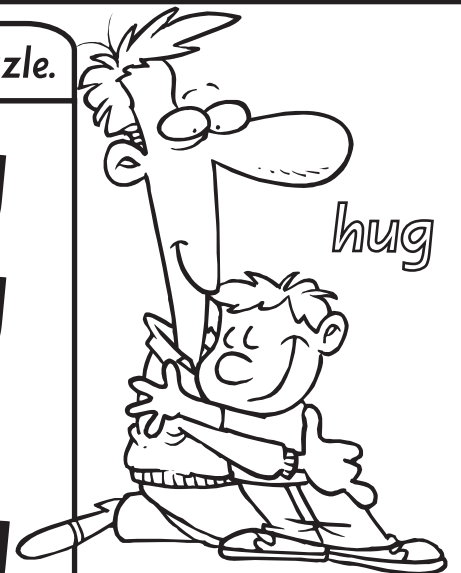



**mum**

Use these letters to make um words.

s g r h m y

.....um .....um

.....um .....um

.....um .....um

Trace the correct sentence.

Mum can hum.

Mum has some gum.

Mum does a sum.



Write the sentence here.

.....  
.....

Colour the um words in the word puzzle.

sum

$$\begin{array}{r} 6 \\ + 3 \\ \hline \\ \hline \end{array}$$

s	g	r	y	d
m	u	u	u	i
h	u	m	m	q
g	g	m	i	x
z	b	o	r	m

hum sum  
rum gum  
yum mum

Use these letters to make un words.

b s f r g n

.....un .....un  
.....un .....un  
.....un .....un

# SUN

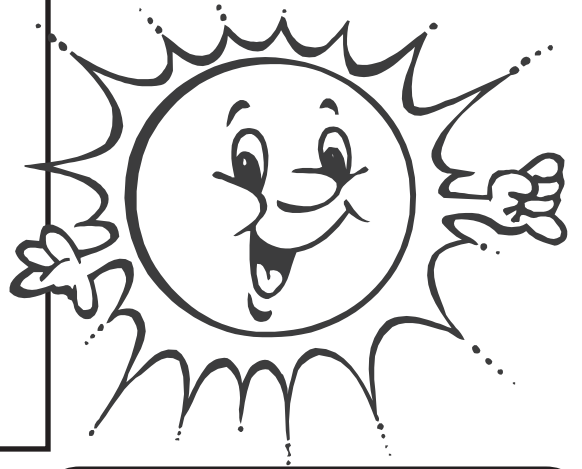

Trace the correct sentence.

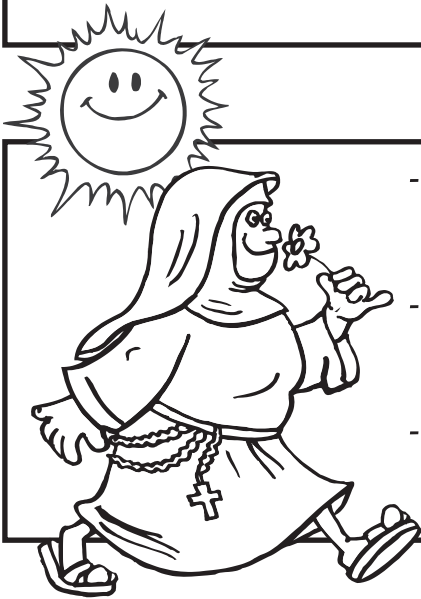

The nun is in the sun.  
The nun has a bun.  
The nun can run.

Write the sentence here.

.....  
.....

Colour the un words in the word puzzle.

a	f	x	c	i
u	r	u	n	u
g	q	p	n	s
l	u	u	t	u
b	u	n	u	n

nun sun  
gun run  
bun fun  
pun

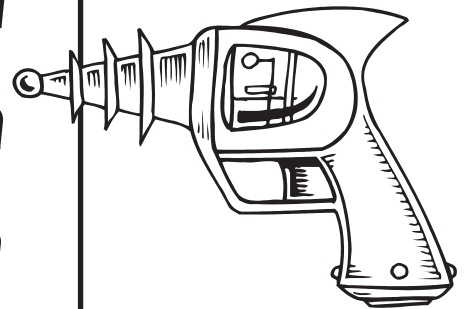

gun

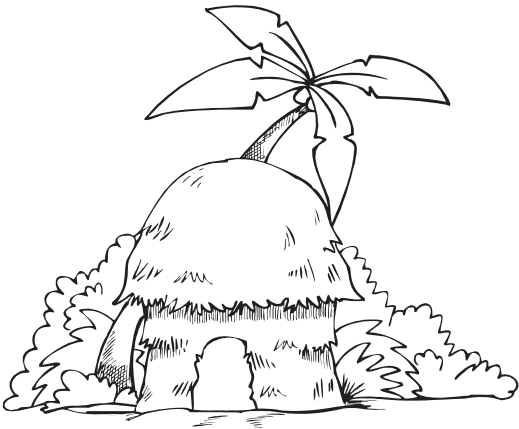

hut

Use these letters to make ut words.

b g n h c r

.....ut .....ut

.....ut .....ut

.....ut .....ut

Trace the correct sentence.

A hut on a nut.

I cut a nut.

Nuts on a hut.



Write the sentence here.

.....  
.....

Colour the ut words in the word puzzle.

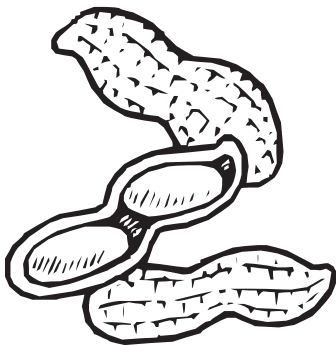

nuts

r	z	b	h	s
t	n	c	u	t
p	r	u	t	t
u	j	u	t	u
y	f	g	u	t

cut but

hut rut

nut jut

gut tut

Use these letters to make ed words.

f r l b T w

.....ed

.....ed

.....ed

.....ed

.....ed

.....ed

# bed

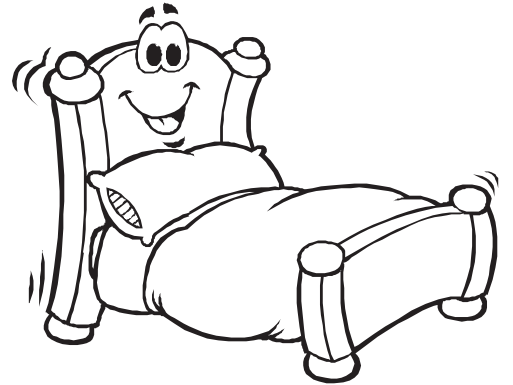

Trace the correct sentence.

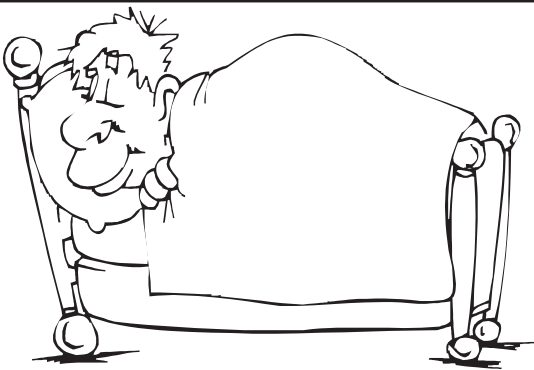

Mum fed Ted.

Ted is in the bed.

The bed is on Ted.

Write the sentence here.

.....  
.....

Colour the ed words in the word puzzle.

l	z	T	q	i
e	k	f	e	d
d	b	w	e	d
r	e	d	a	k
k	d	N	e	d

wed

red

Ted

bed

fed

Ned

led



wed



Use these letters to make eg words.

b l k M p

.....eg      .....eg

.....eg      .....eg

.....eg

Trace the correct sentence.

Meg has a peg.

Meg has a keg.

A dog has a peg.



Write the sentence here.

.....

.....

Colour the eg words in the word puzzle.

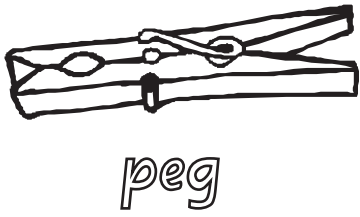

n	G	p	u	k
z	p	r	l	e
b	b	p	e	g
q	M	e	g	g
c	i	o	g	g

peg      Greg

leg      Meg

keg      beg

Use these letters to make en words.

t d p h B m

.....en .....en

.....en .....en

.....en .....en

# hen

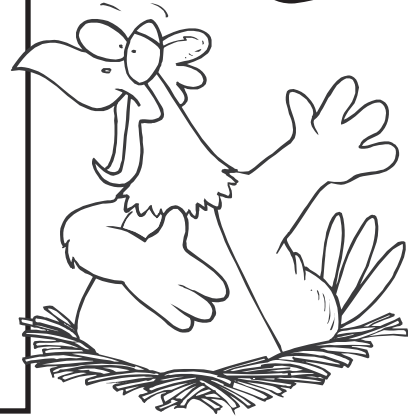

Trace the correct sentence.

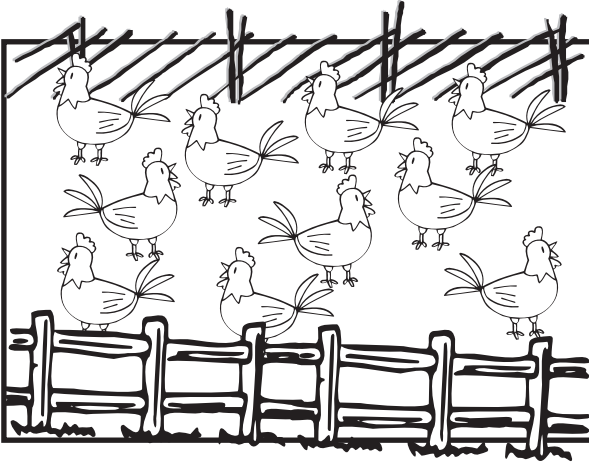

Ten hens in a pen.

Ben has ten hens.

Ken has ten pens.

Write the sentence here.

.....  
.....

Colour the en words in the word puzzle.

d	h	y	e	n
p	e	n	q	m
h	e	n	t	e
d	u	z	e	n
p	L	e	n	d

yen    ten  
pen    zen  
den    men  
hen    Len

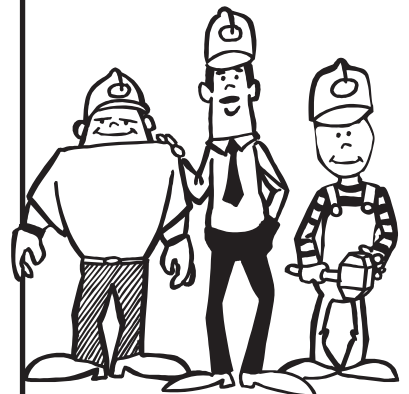

men



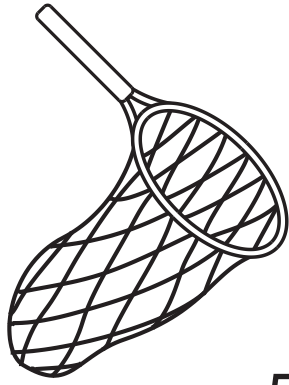

net

Use these letters to make et words.

g m s l p j

.....et

.....et

.....et

.....et

.....et

.....et

Trace the correct sentence.

The pet is wet.

The vet has a pet.

The vet has a net.



Write the sentence here.

.....  
.....

Colour the et words in the word puzzle.

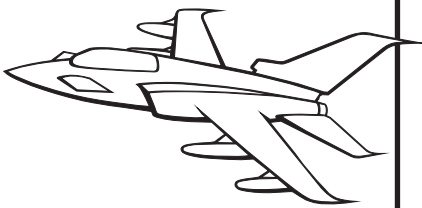

jet

m	g	g	e	t
e	l	s	e	t
t	w	e	t	b
f	j	e	t	e
c	f	y	e	t

get

let

met

jet

set





bet

wet

yet

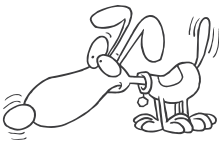
# REVISION

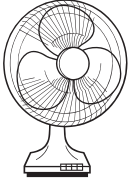

Write the words to match the pictures.

<p>fan</p> <p>mug</p> <p>pup</p> <p>bus</p> <p>nap</p> <p>bib</p>	 <p>fan</p>	 <p>mug</p>	 <p>pup</p>
	 <p>bus</p>	 <p>nap</p>	 <p>bib</p>

Write some rhyming words.



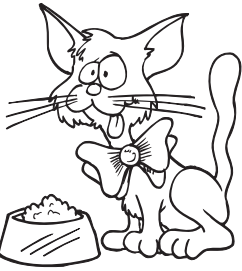
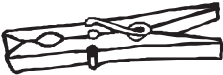
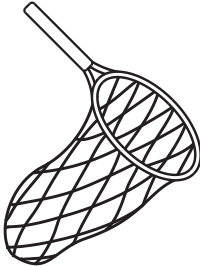





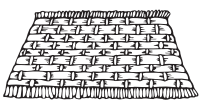

fan	mug	nap	bib
.....	.....	.....	.....
.....	.....	.....	.....
.....	.....	.....	.....

Write the word.

 <p>.....</p>	 <p>.....</p>	 <p>.....</p>	 <p>.....</p>
--	--	---	--

# REVISION

Write the words. Colour the rhyming pictures in each row.

 <p>.....</p>	 <p>.....</p>	 <p>.....</p>	 <p>.....</p>
 <p>.....</p>	 <p>.....</p>	 <p>.....</p>	 <p>.....</p>
 <p>.....</p>	 <p>.....</p>	 <p>.....</p>	 <p>.....</p>

Write the missing words.

- The dog sat on the .....
- Dad has a ..... on his leg.
- Run and get the .....
- The ..... got the rat.
- It is fun to ..... in the sun.

bug



mat

run

mop

cat

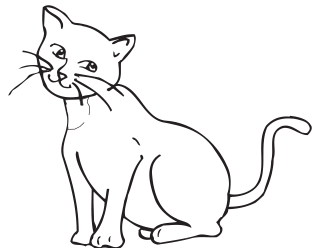
Colour the pictures that rhyme with lap.

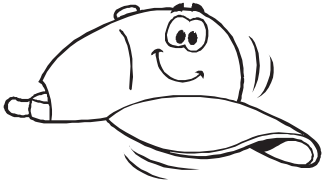
			
---	---	--	---

# REVISION

Find the words in the wordsearch.

cat	bug	nun
cab	mat	bet
fat	get	bin
gap	got	men
can	cub	mop
rib	led	sob
win	beg	gut

g	e	t	m	d	c	a	b
m	b	e	g	e	a	c	u
o	e	s	g	o	n	u	g
l	t	w	o	u	t	b	m
e	g	r	i	b	t	i	a
d	f	a	t	n	u	n	t
x	m	o	p	c	a	t	m

Write the correct sentence under the picture.



.....

.....

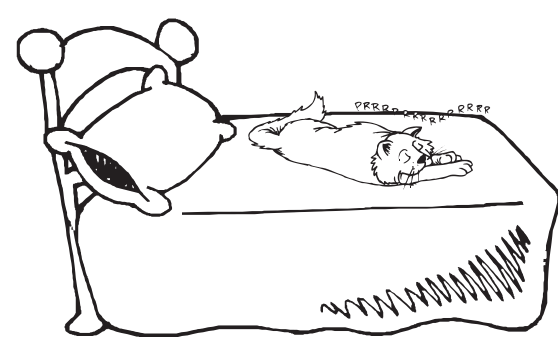

.....

.....

**A cat on a bed.**

**A bug on a web.**

# REVISION

Colour the picture in each row that rhymes with the word.

rag



sip

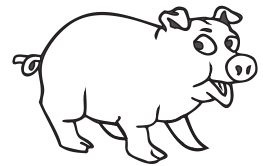
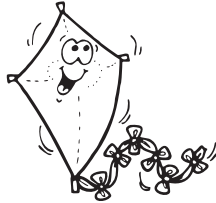

jog



dug

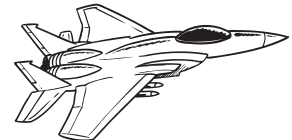





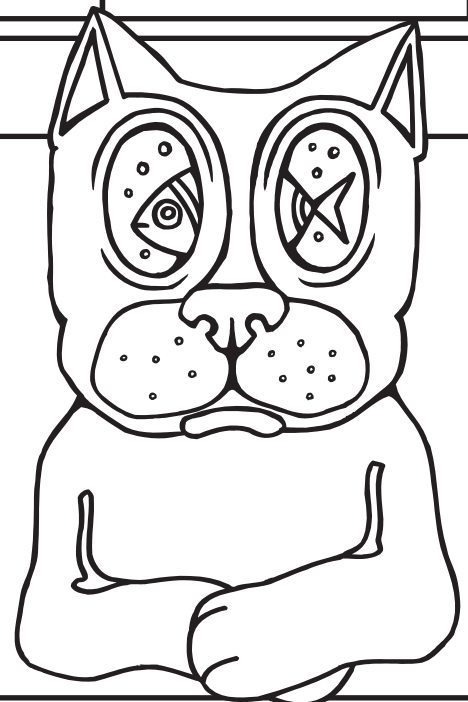

Write yes or no.

1. A dog can run. ....
2. A pig can hop. ....
3. The sun is hot. ....
4. Dad can pat a hat. ....
5. A wig can do a jig. ....
6. A log can jog. ....

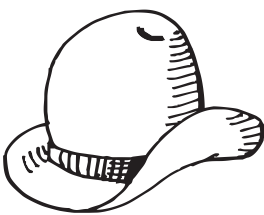

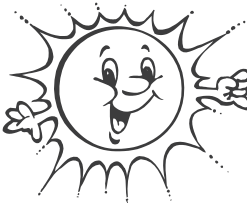
# REVISION

Circle the correct word. Write the word.

 <p>hat hip hug</p> <p>.....</p>	 <p>bag bib bed</p> <p>.....</p>	 <p>sun sat sad</p> <p>.....</p>
 <p>leg lip lab</p> <p>.....</p>	 <p>dog dot dad</p> <p>.....</p>	 <p>hog ham hut</p> <p>.....</p>

Join the letters to make words. Write the words.











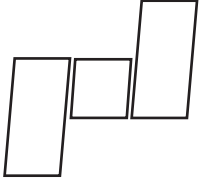

<p>d c r w p t</p>	<p>an ob ax ad ip op</p>	<p>..... dad .....</p> <p>.....</p> <p>.....</p> <p>.....</p> <p>.....</p> <p>.....</p>
--	--	---

# REVISION

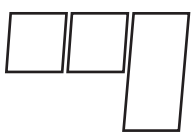
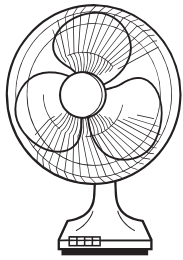
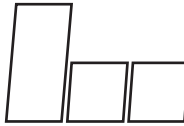
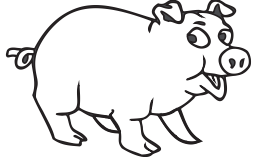
Colour the words that rhyme in each row.

 <b>lid</b>	hid	lip	rid	kid	did
 <b>top</b>	hog	pop	nod	cop	hop
 <b>bug</b>	hug	jug	tug	mum	rub

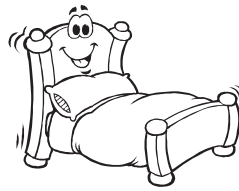
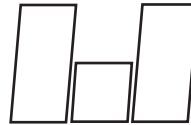
Write the words.

# REVISION

Colour the correct word.

1. Ken sat in a red **van** **bed**.
2. The pot is **dot** **hot**.
3. Mum had a **nap** **sad**.
4. A **dog** **lip** on a rug.
5. Pam did the **tub** **sum**.

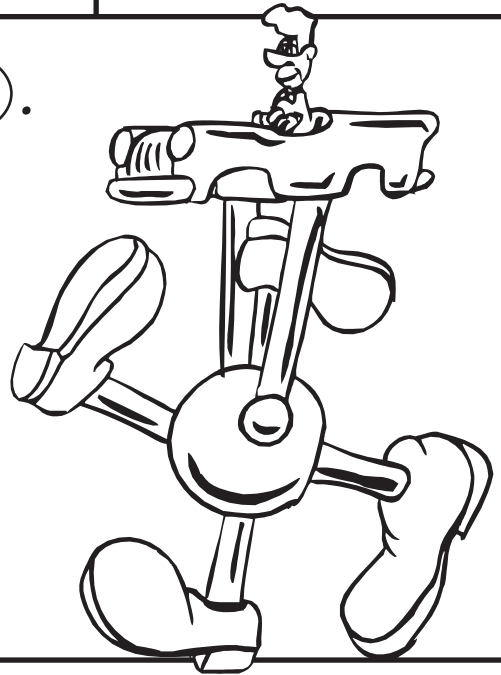

Write the correct letters to make the words.

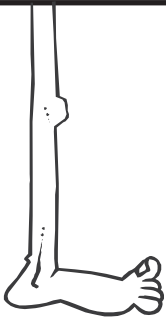

**l** ..... ..

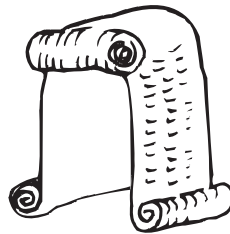

**w** ..... ..

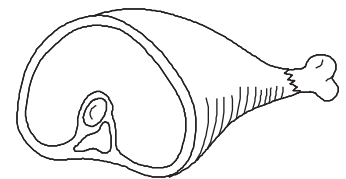

**h** ..... ..



**b** ..... ..



**r** ..... ..

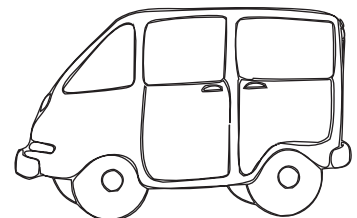

**u** ..... ..



# REVISION

Circle the word that doesn't belong.

ham lap dam jam Sam ram

rob mob sob dob kin job cob

cut but gut jet nut rut hut

Look at the picture. Write the missing word.



cat and .....



man and .....

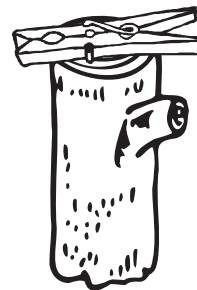

peg and .....

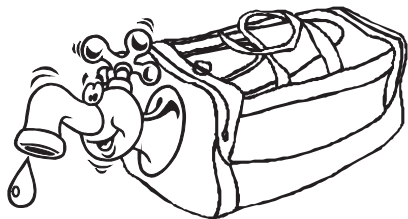

bag and .....

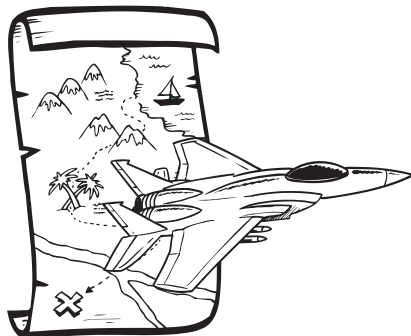

jet and .....

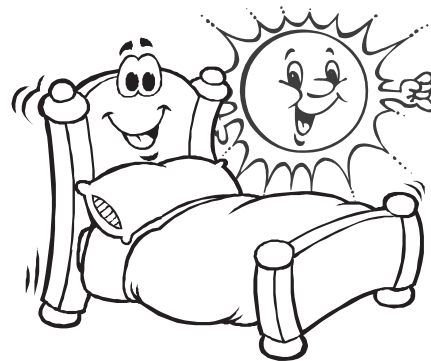

bed and .....

# REVISION

Draw a rhyming picture and write the word.

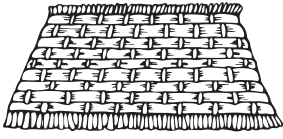

mat

.....



fin

.....



top

.....



cot

.....

Fill in the missing letters to make some words. Write the words.

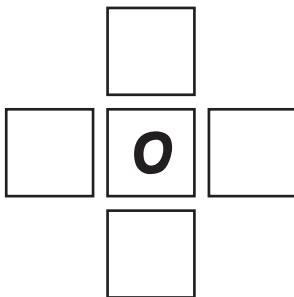

.....

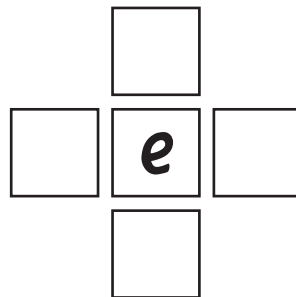

.....

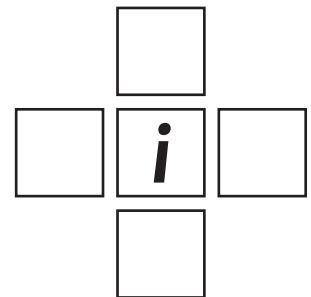

.....

Unjumble the letters and write the words.

amn .....

bnu .....

gip .....

nif .....

tgo .....

nua .....

jbo .....

obr .....

tam .....

pmo .....

dre .....



toc .....

# REVISION

Colour the -in words red, the -et words blue and the -am words yellow.

pin	set	ham	yet	dam
Sam	met	tin	wet	fin
win	din	bet	yam	ram

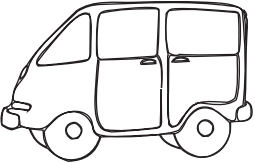
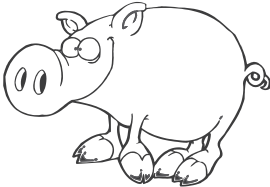
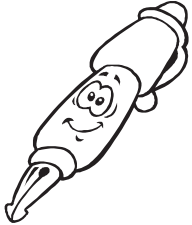
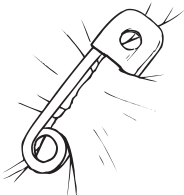
Circle the correct word. Write the word.

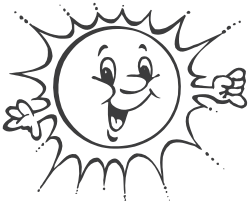
 <p>man van pan</p> <p>.....</p>	 <p>pig wig dig</p> <p>.....</p>	 <p>ten men pen</p> <p>.....</p>
 <p>win pin fin</p> <p>.....</p>	 <p>hat mat sat</p> <p>.....</p>	 <p>sun fun run</p> <p>.....</p>

Colour the letters to make the word. Write the word.

let	l	m	u	z	e	t	.....
rob	r	m	o	d	b	f	.....
gap	e	g	p	a	p	t	.....

# REVISION

Unscramble the letters and write the words. Draw a line to the picture.

d g i

.....



u n r

.....

c n a

.....



a m t

.....



m m u

.....

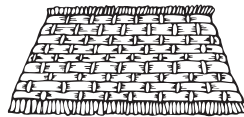

Colour the picture that has the sound in it.

ad



6



ig



un

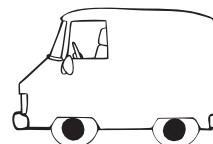
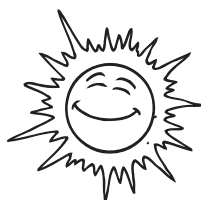



# REVISION

Write the missing word.

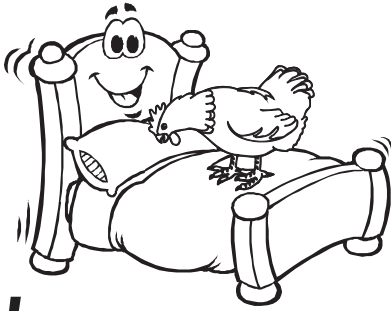

a hen on a .....



a bat on a .....

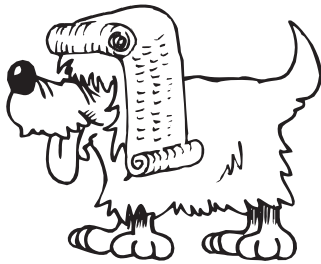

a dog in a .....

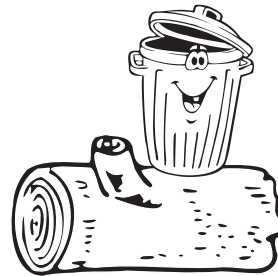

a bin on a .....

Finish the sentences.

1. Mum has a .....
2. Bob did a .....
3. Can you ..... the bag?
4. Pop has a ..... van.
5. The ..... is in the box.

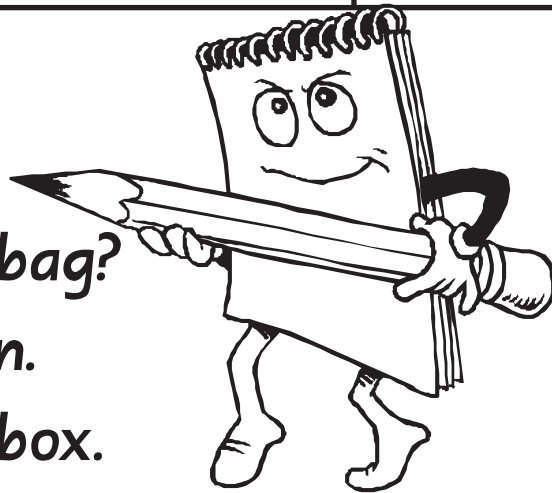

get  
red  
job  
pup  
nap

Write the word.

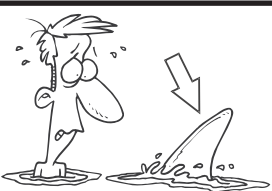

.....



.....



.....

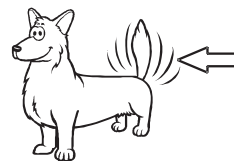





.....

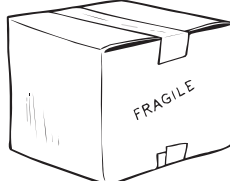

.....

# REVISION

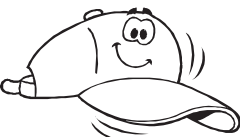
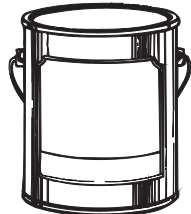
Write the correct ending.

 <p><b>at</b> <b>an</b> <b>am</b></p> <p><b>p</b> .....</p>	 <p><b>ot</b> <b>ox</b> <b>op</b></p> <p><b>b</b> .....</p>	 <p><b>od</b> <b>ot</b> <b>og</b></p> <p><b>p</b> .....</p>
 <p><b>am</b> <b>at</b> <b>ap</b></p> <p><b>c</b> .....</p>	 <p><b>is</b> <b>in</b> <b>im</b></p> <p><b>t</b> .....</p>	 <p><b>um</b> <b>ut</b> <b>un</b></p> <p><b>n</b> .....</p>

Colour the letters to make the word. Write the word.

<b>wax</b>	<table border="1"> <tr> <td>t</td><td>w</td><td>a</td><td>u</td><td>x</td><td>t</td> </tr> </table> <p>.....</p>	t	w	a	u	x	t	
t	w	a	u	x	t			
<b>rib</b>	<table border="1"> <tr> <td>r</td><td>m</td><td>i</td><td>w</td><td>b</td><td>e</td> </tr> </table> <p>.....</p>	r	m	i	w	b	e	
r	m	i	w	b	e			
<b>bog</b>	<table border="1"> <tr> <td>e</td><td>b</td><td>o</td><td>a</td><td>p</td><td>g</td> </tr> </table> <p>.....</p>	e	b	o	a	p	g	
e	b	o	a	p	g			
<b>gum</b>	<table border="1"> <tr> <td>a</td><td>g</td><td>u</td><td>z</td><td>m</td><td>i</td> </tr> </table> <p>.....</p>	a	g	u	z	m	i	
a	g	u	z	m	i			
<b>pan</b>	<table border="1"> <tr> <td>p</td><td>s</td><td>o</td><td>a</td><td>b</td><td>n</td> </tr> </table> <p>.....</p>	p	s	o	a	b	n	
p	s	o	a	b	n			
<b>bet</b>	<table border="1"> <tr> <td>b</td><td>g</td><td>p</td><td>e</td><td>p</td><td>t</td> </tr> </table> <p>.....</p>	b	g	p	e	p	t	
b	g	p	e	p	t			

Write the word.

 <p><b>p</b> .....</p>	 <p><b>b</b> .....</p>	 <p><b>s</b> .....</p>
---	---	---

# REVISION

Write the words in their correct shape.

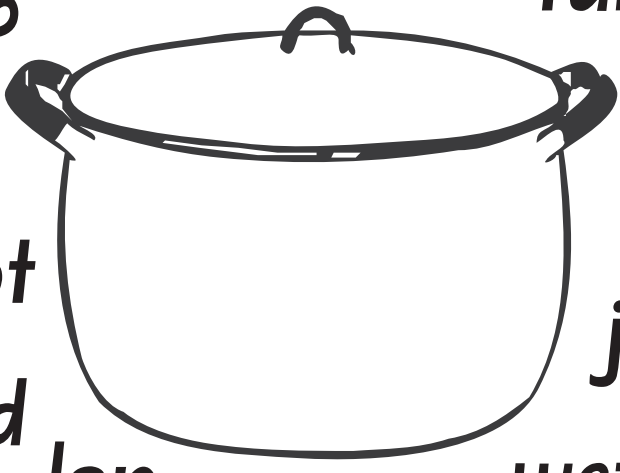
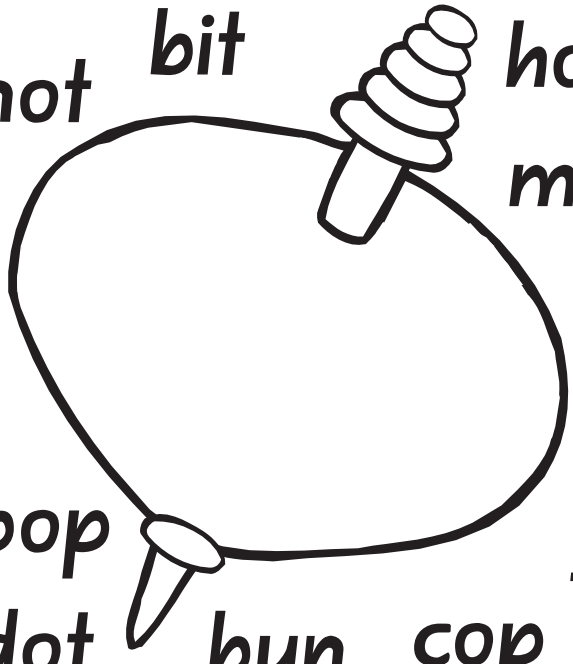

not bit hop hot got pop  
mop fun  
rot  
bop fed jot  
dot bun cop lop wet

Write the correct sentence under the picture.

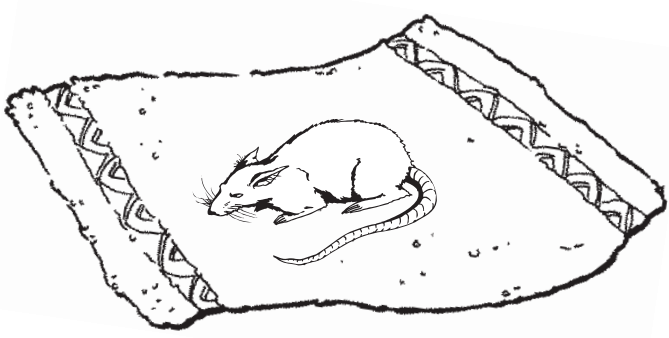

.....  
.....



.....  
.....

The cat is on the rug.

A pig is on a pot.

The rat is on the rug.

A peg is on a pot.



<p>Can you read these rhyming words?</p>	<p>☺ cab ☺ dab ☺ jab ☺ lab ☺ nab ☺ tab</p>	<p>☺ had ☺ fad ☺ bad ☺ pad ☺ sad ☺ dad ☺ mad ☺ lad</p>	<p>☺ bag ☺ gag ☺ rag ☺ hag ☺ wag ☺ jag ☺ tag ☺ lag ☺ sag ☺ nag</p>	<p>☺ jam ☺ ham ☺ dam ☺ ram ☺ yam ☺ Sam</p>
<p>☺ ban ☺ ran ☺ can ☺ Dan ☺ fan ☺ Jan ☺ van ☺ Nan ☺ man ☺ tan ☺ pan</p>	<p>☺ cap ☺ gap ☺ sap ☺ map ☺ lap ☺ yap ☺ tap ☺ zap ☺ rap ☺ nap</p>	<p>☺ cat ☺ hat ☺ rat ☺ pat ☺ mat ☺ uat ☺ fat ☺ bat ☺ sat</p>	<p>☺ tax ☺ wax ☺ fax ☺ Max ☺ sax ☺ vax ☺ lax</p>	<p>☺ bib ☺ nib ☺ fib ☺ rib ☺ jib</p>
<p>☺ did ☺ hid ☺ kid ☺ lid ☺ rid ☺ bid ☺ Sid</p>	<p>☺ pig ☺ gig ☺ big ☺ jig ☺ fig ☺ dig ☺ wig ☺ rig</p>	<p>☺ rim ☺ Tim ☺ Kim ☺ dim ☺ him ☺ Jim ☺ vim</p>	<p>☺ bin ☺ din ☺ tin ☺ gin ☺ pin ☺ sin ☺ fin ☺ win ☺ kin</p>	<p>☺ lip ☺ hip ☺ nip ☺ kip ☺ sip ☺ pip ☺ tip ☺ zip ☺ dip</p>
<p>☺ bit ☺ sit ☺ kit ☺ pit ☺ fit ☺ lit ☺ wit ☺ hit</p>	<p>☺ cob ☺ dob ☺ rob ☺ fob ☺ sob ☺ hob ☺ mob ☺ lob ☺ nob ☺ job ☺ Bob</p>	<p>☺ cod ☺ nod ☺ pod ☺ rod ☺ sod</p>	<p>☺ dog ☺ hog ☺ bog ☺ fog ☺ cog ☺ jog ☺ log</p>	<p>☺ top ☺ lop ☺ pop ☺ sop ☺ cop ☺ mop ☺ bop ☺ hop</p>
<p>☺ hot ☺ dot ☺ not ☺ jot ☺ lot ☺ rot ☺ got ☺ tot ☺ cot ☺ pot</p>	<p>☺ rub ☺ dub ☺ tub ☺ pub ☺ hub ☺ bub ☺ sub ☺ cub</p>	<p>☺ bug ☺ pug ☺ dug ☺ rug ☺ hug ☺ tug ☺ jug ☺ lug ☺ mug</p>	<p>☺ hum ☺ mum ☺ rum ☺ sum ☺ gum ☺ yum</p>	<p>☺ bun ☺ sun ☺ fun ☺ run ☺ gun ☺ nun ☺ pun</p>
<p>☺ hut ☺ mut ☺ cut ☺ jut ☺ but ☺ nut ☺ gut ☺ rut</p>	<p>☺ bed ☺ Jed ☺ red ☺ Ned ☺ fed ☺ led ☺ Ted ☺ wed</p>	<p>☺ beg ☺ leg ☺ keg ☺ peg ☺ Meg</p>	<p>☺ hen ☺ ten ☺ pen ☺ Ben ☺ den ☺ Ken ☺ men ☺ Len ☺ Jen ☺ yen ☺ zen</p>	<p>☺ get ☺ yet ☺ met ☺ pet ☺ set ☺ jet ☺ wet ☺ bet ☺ let ☺ net ☺ uet</p>

‘Learning to Read ~ Word Families’ has been designed to help students recognise patterns within words and to blend sounds together to make three letter words.

The word families treated are:

ab ad ag am an ap at ax  
 ib id ig im in ip it  
 ob od og op ot  
 ub ug um un ut  
 ed eg en et

This book is suitable for the following grades in different states.

	NSW	ACT	VIC	TAS	WA	NT	SA	QLD	NZ	
K, Prep	✓	✓	✓	✓						LOWER MIDDLE UPPER
1	✓	✓	✓	✓	✓	✓	✓	✓	✓	
2					✓	✓	✓	✓	✓	
3										
4										
5										
6										
7										

Burrabooks publications are written by Australian teachers who have had extensive classroom experience.

For more information visit:

[www.burrabooks.com.au](http://www.burrabooks.com.au)

**BUR-203**  
 ISBN 13: 978-1-86402-007-6  
 ISBN 10: 1-86402-007-5



9 781864 020076



**BURRABOOKS**

[www.burrabooks.com.au](http://www.burrabooks.com.au)  
[mail@burrabooks.com.au](mailto:mail@burrabooks.com.au)