

MIDDLE
and
UPPER
Grades

EDUCATIONAL
WORKSHEETS

PRIMARY PUZZLES and PATTERNS



Easy to Challenging

BURRA
BOOKS

P R I M A R Y

P U Z Z L E S

A N D

P A T T E R N S

Primary Puzzles and Patterns

written by Greg Porich

© Burrabooks Pty Ltd.

First Published 2006

ABN 22 070 006 085

P. O. Box 611,

Moruya NSW 2537

Ph: 0244 742 355

Fax: 0244 742 399

www.burrabooks.com.au

All rights reserved.

COPYING FOR EDUCATIONAL PURPOSES

The purchaser of this book is granted permission by the publisher to make copies of the pages within the book, beyond their rights under the Australian Copyright Act 1968 (the Act), provided that the number of copies made does not exceed the number reasonably required for use in one classroom only; that copies are only made by photocopying and are not copied, stored or transmitted by any electronic or digital means; copies are not sold or lent. Copying of this book outside this licence may fall within the educational statutory licence under the Act.

COPYING FOR OTHER PURPOSES

Unless copying is specifically permitted by the educational statutory licence, the licence granted to the purchaser of this book or the fair dealing clause in the Act (for the purposes of study, research, criticism or review), no part of this book may be reproduced, stored in a retrieval system, transmitted in any form or by any means without prior written permission from the publisher.

Some images used with permission of Ron Leishman.

As with all Burrabooks publications every attempt is made to acknowledge copyright. Any infringements are purely coincidental and the publisher offers apologies where applicable.

ISBN 1 86402 138 1

BUR-1130



IMPOSSIBLE

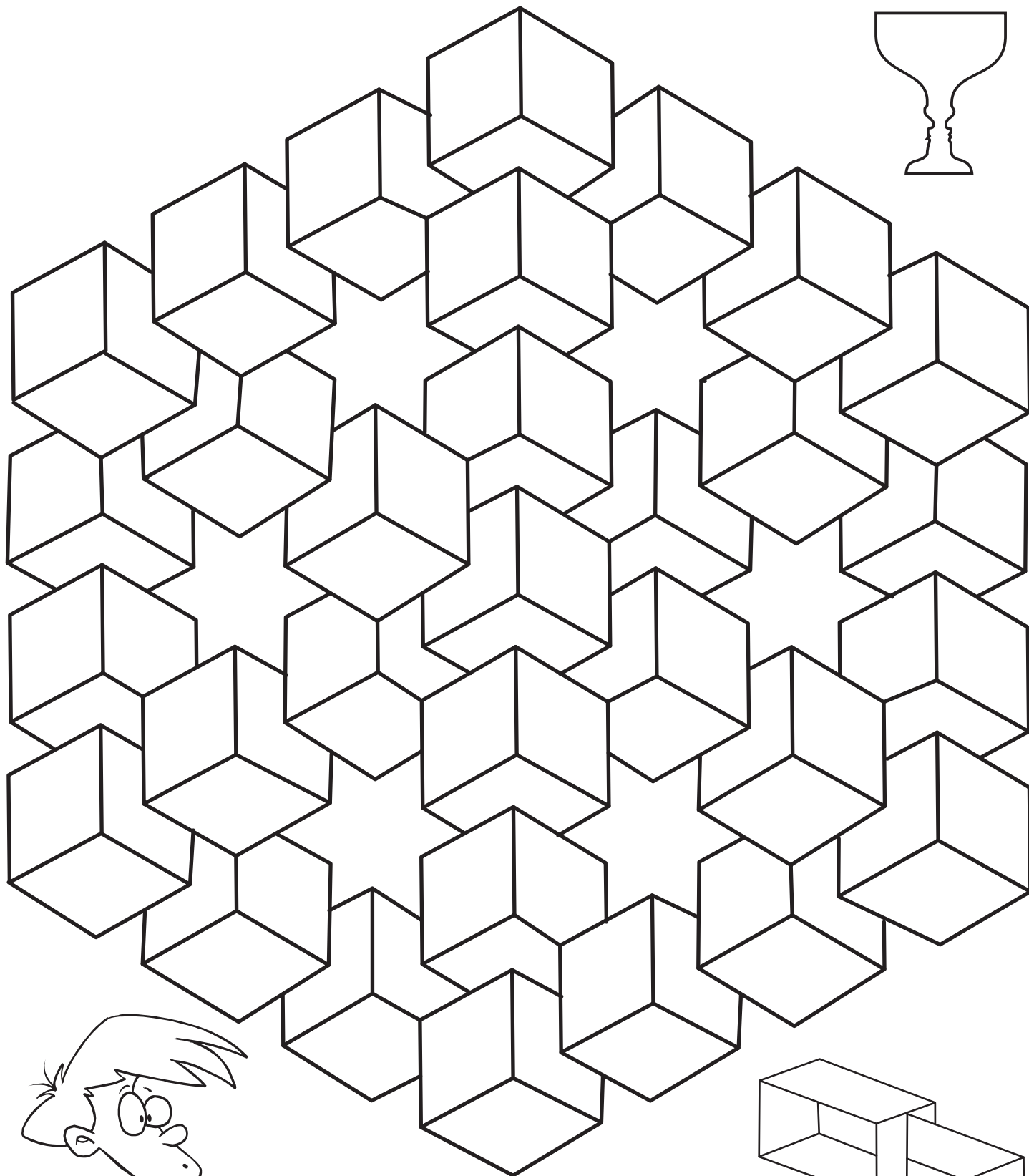

*You might find this impossible to build,
but not impossible to colour.*

Circular Motion

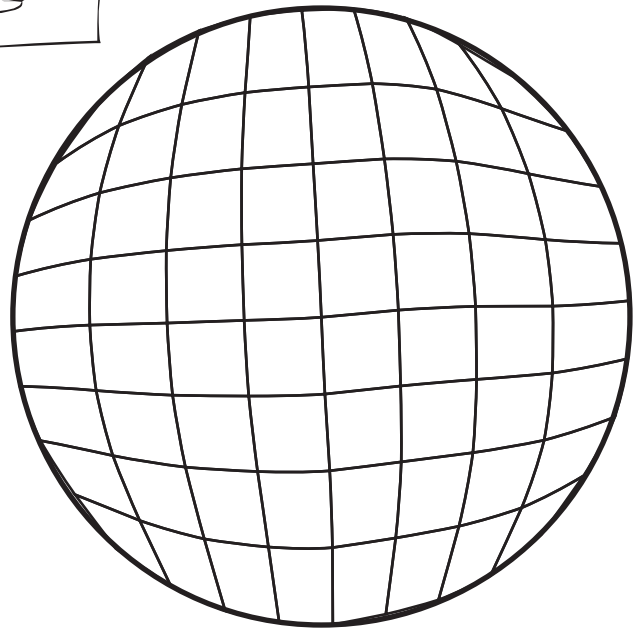
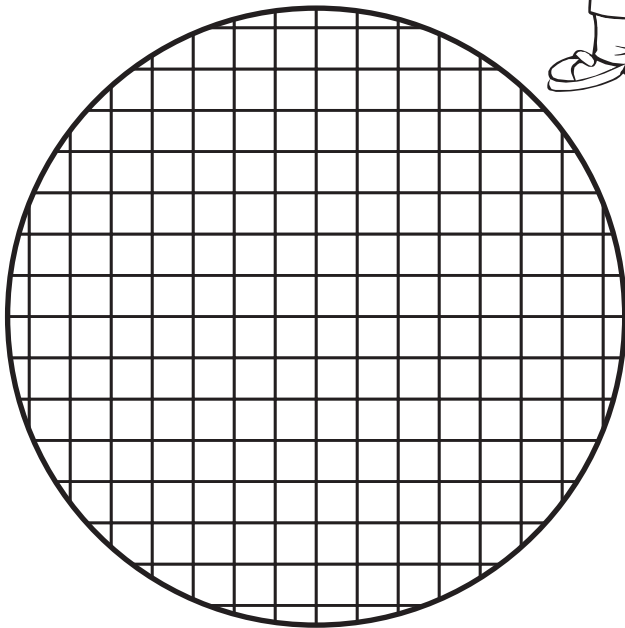
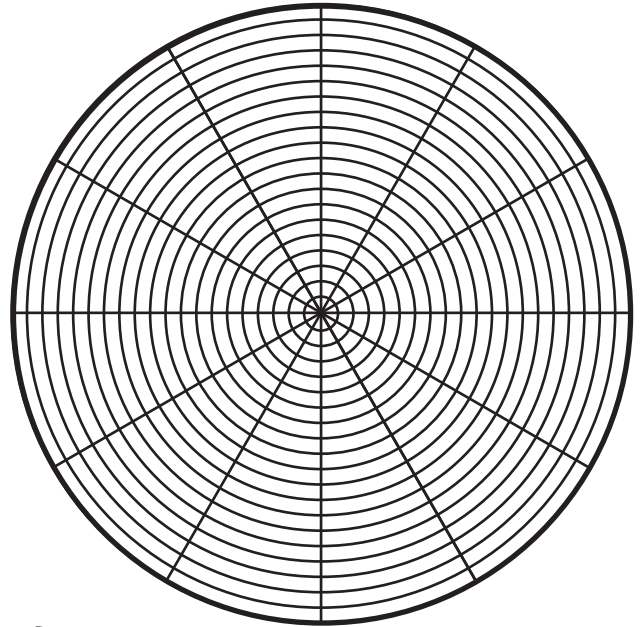
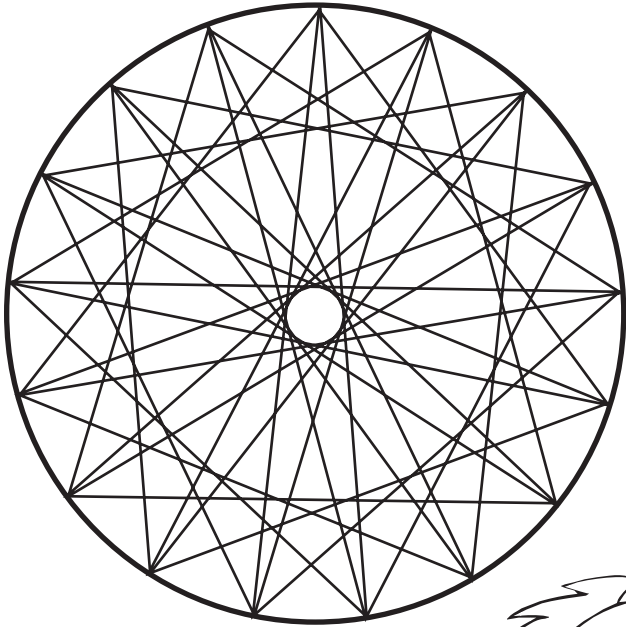

Colour each of these shapes symmetrically.

STAR

Find and colour the five-pointed star hidden in this mosaic pattern. Finish the pattern in your own colours.

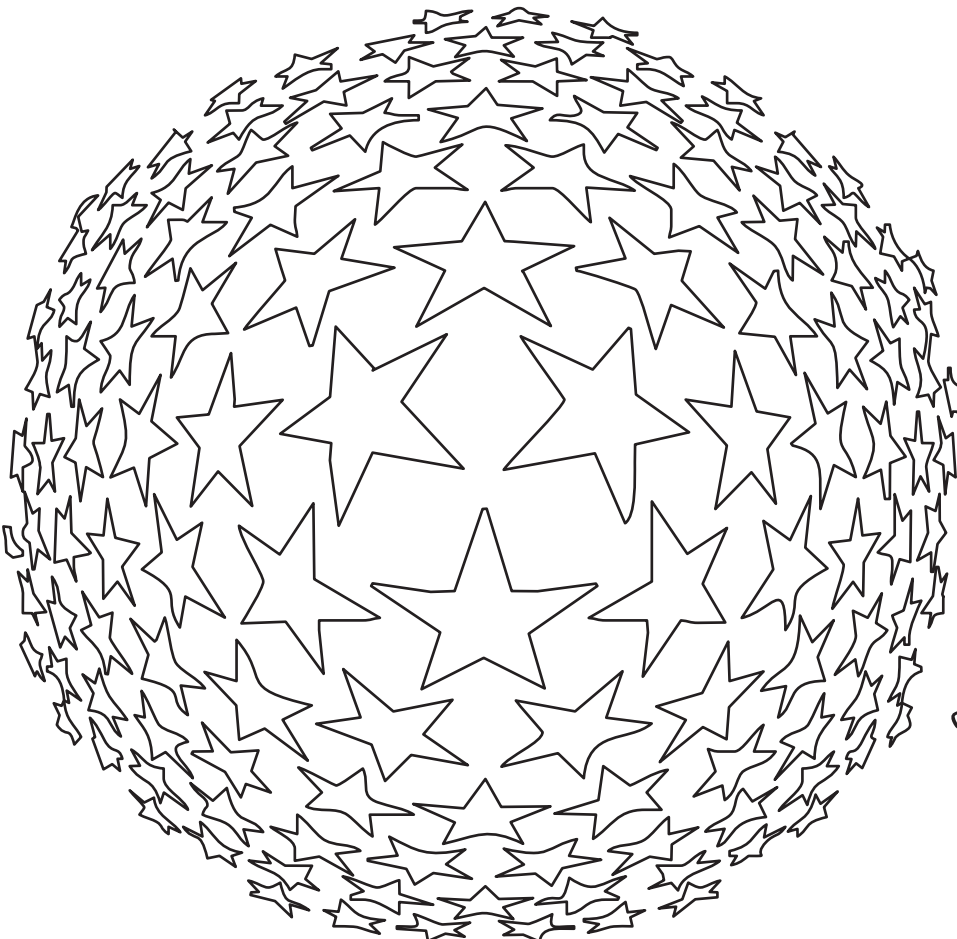
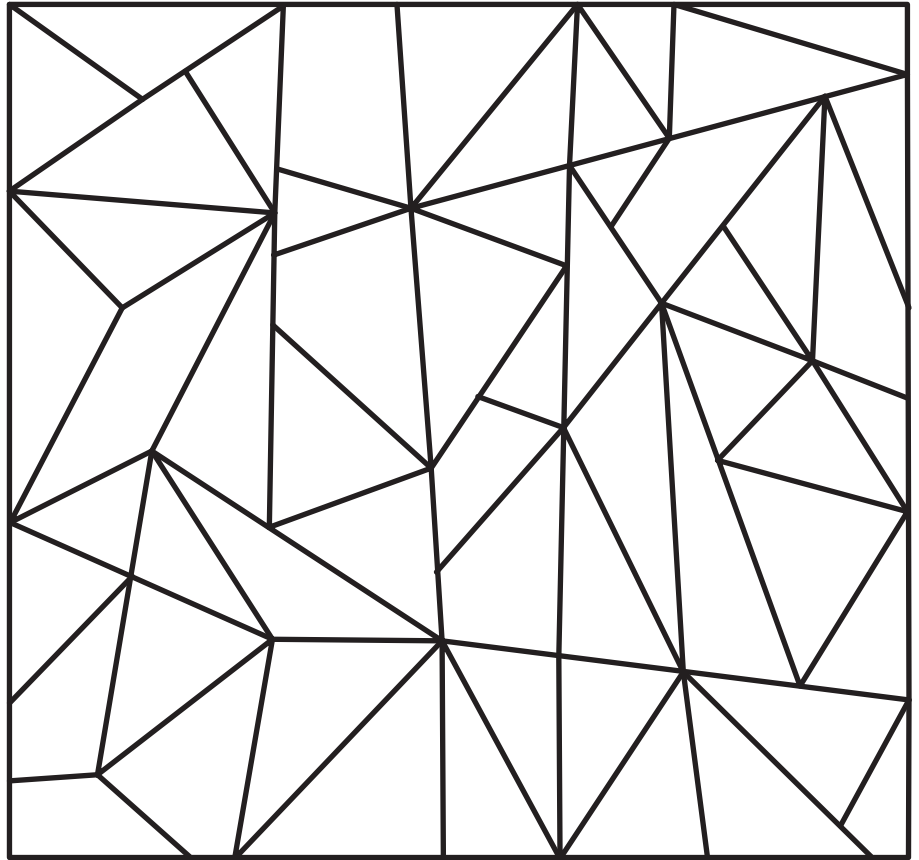

Can you colour this ball of stars in symmetrical colours?



Not a bad job!

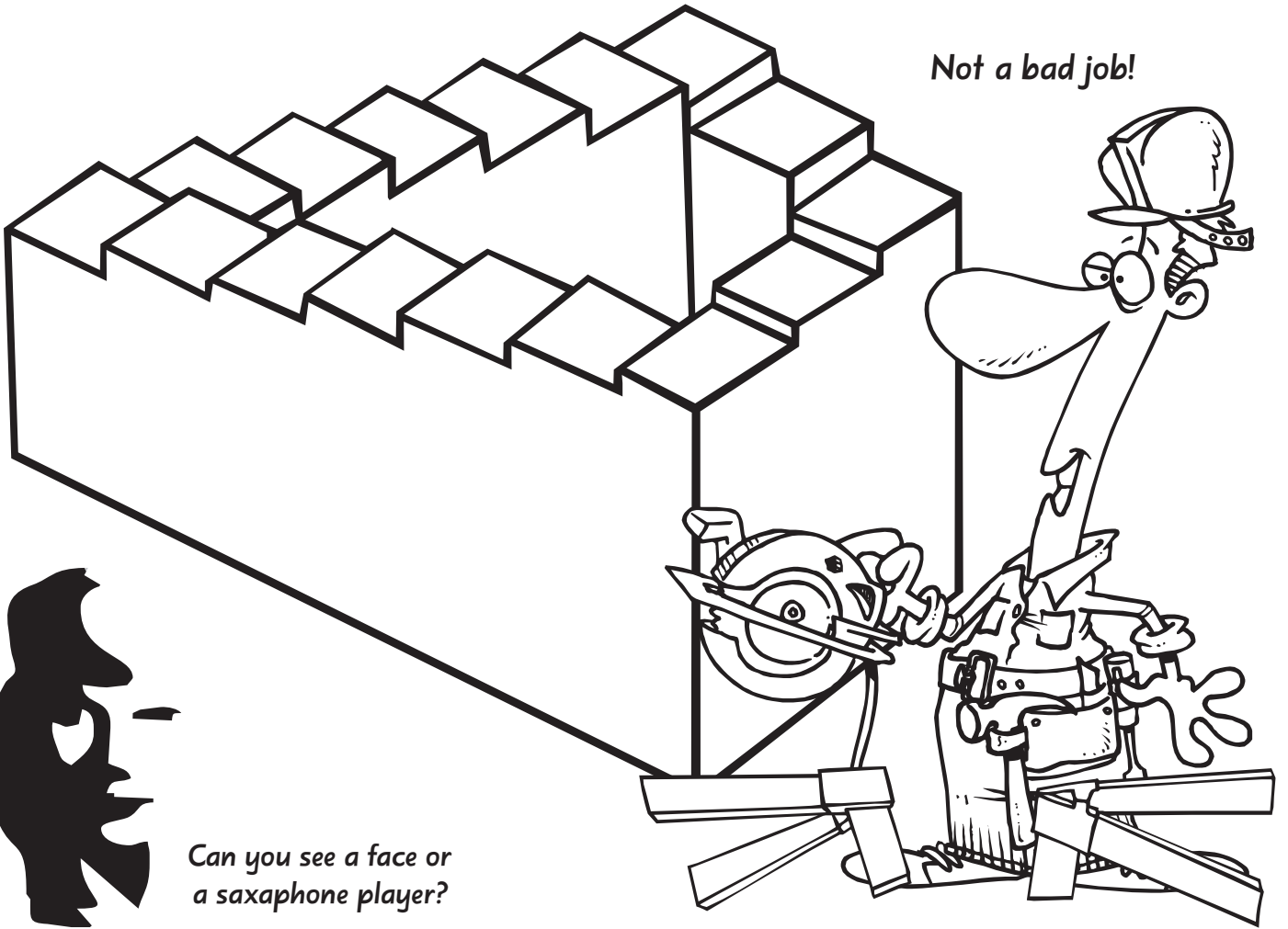

Can you see a face or a saxophone player?

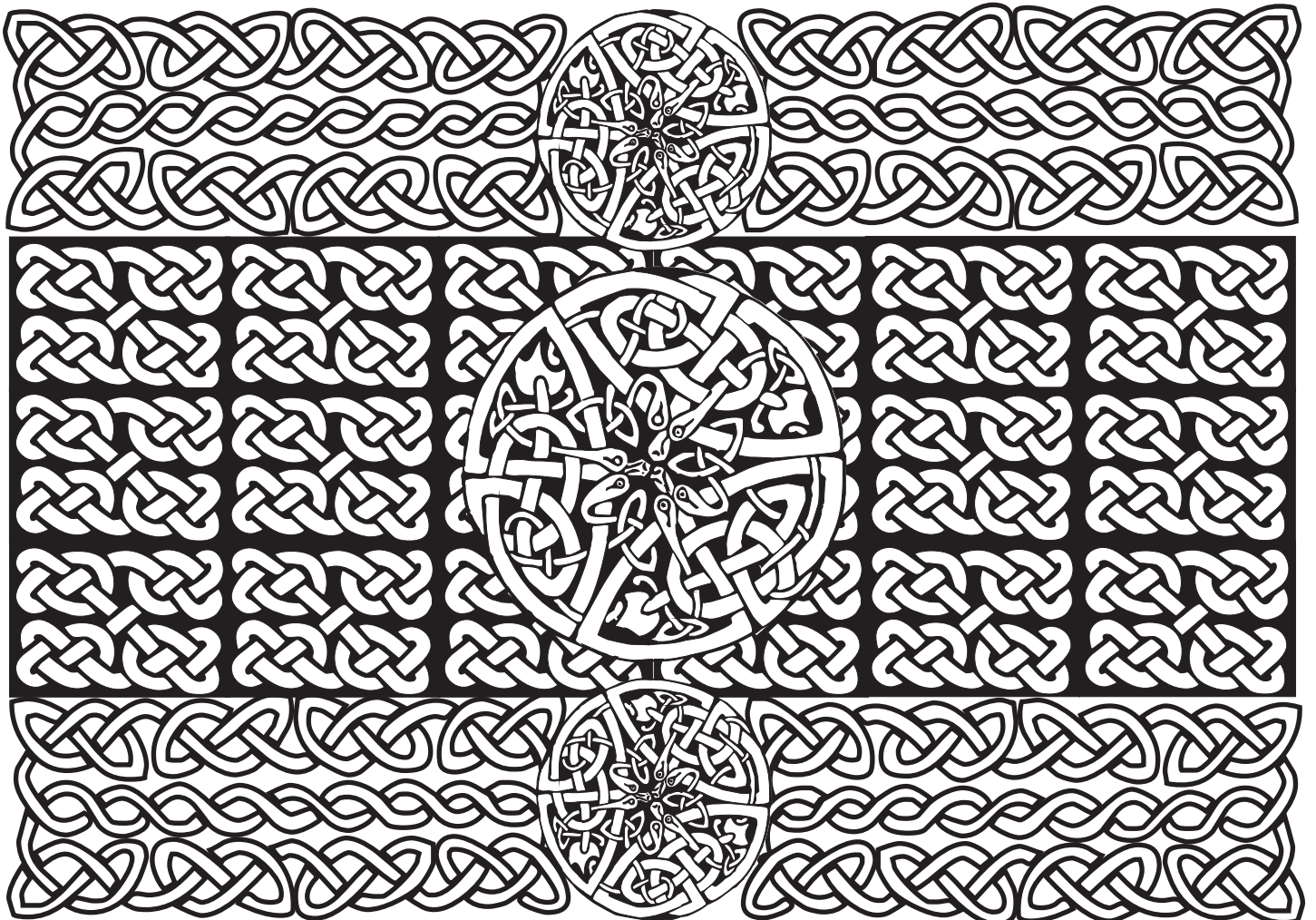

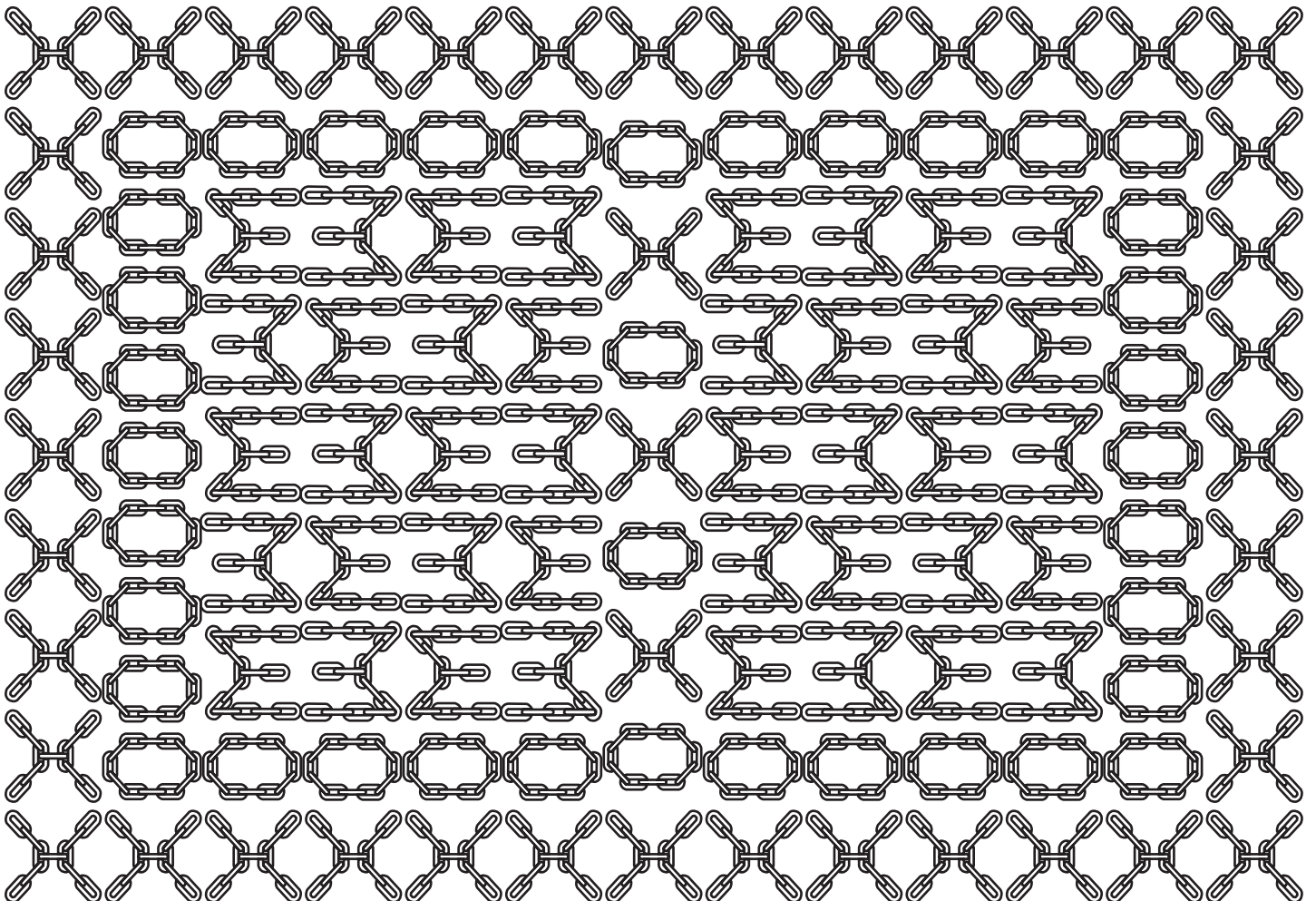
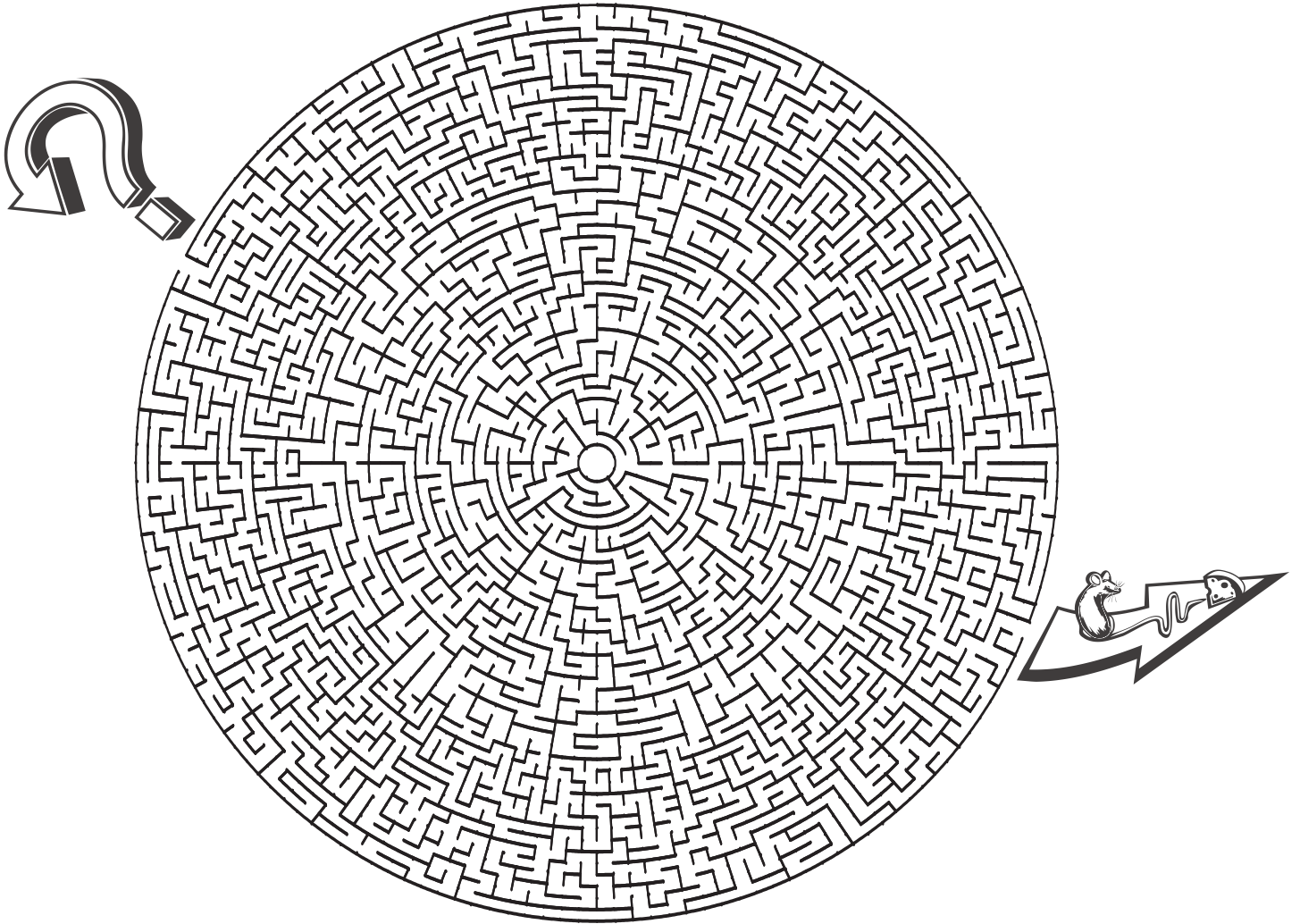

T R I C K Y

Colour this strange object.

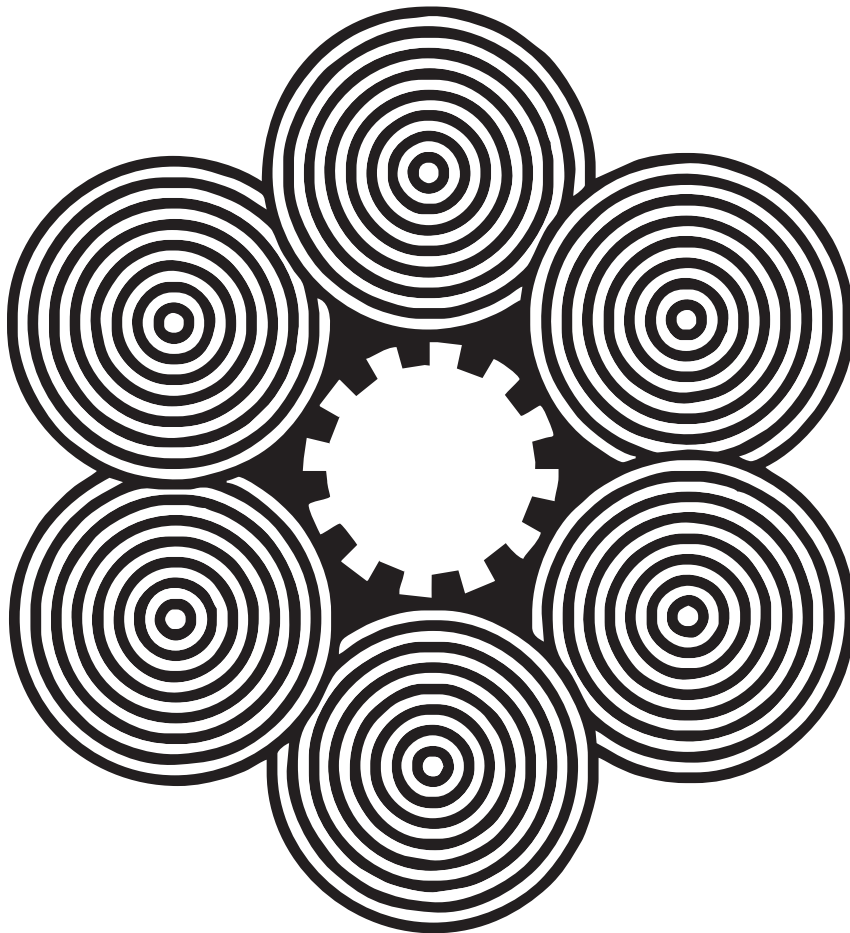
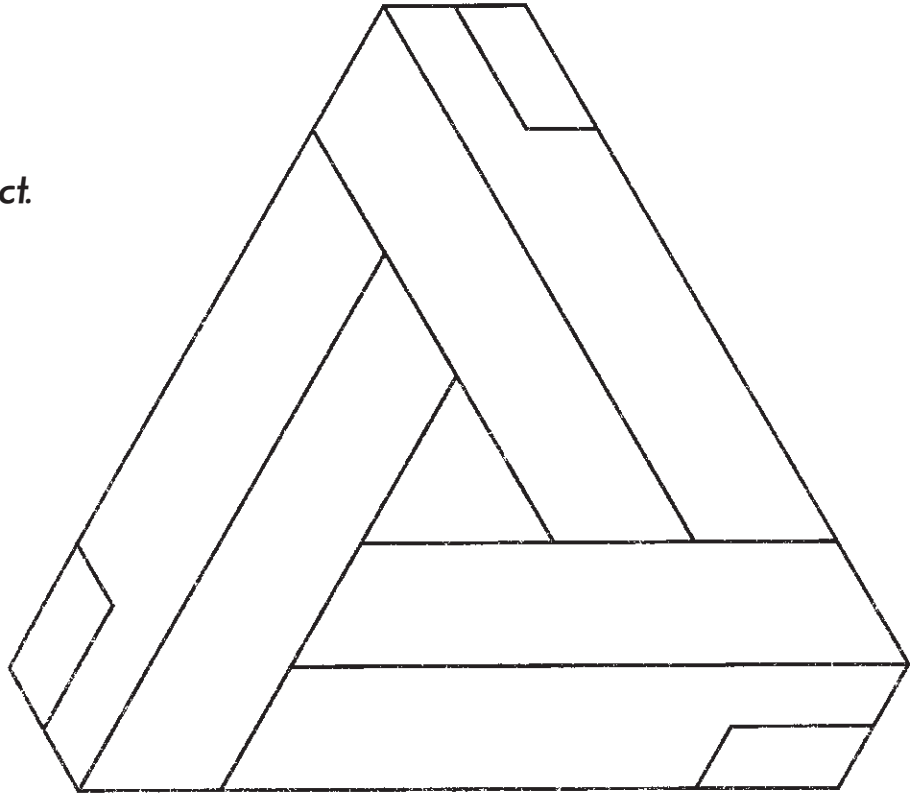
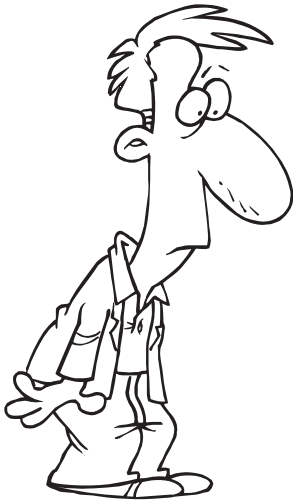

Rotate the page in a small circle. The outside six wheels appear to turn one way, while the inside cog turns the other. Add some colour and see if the effect is still there.

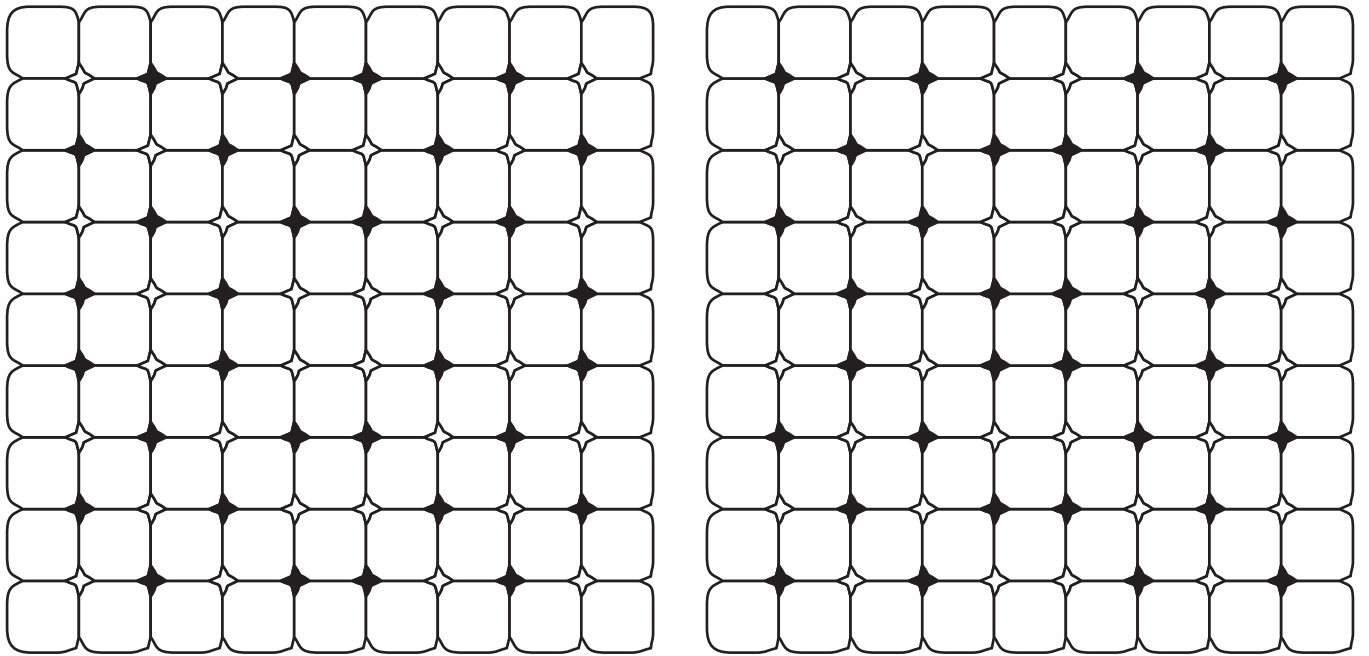

Colour the larger squares in a checkerboard colour scheme.

Do not colour the small black and white stars.

One picture will seem to move away from you while the other will come closer.

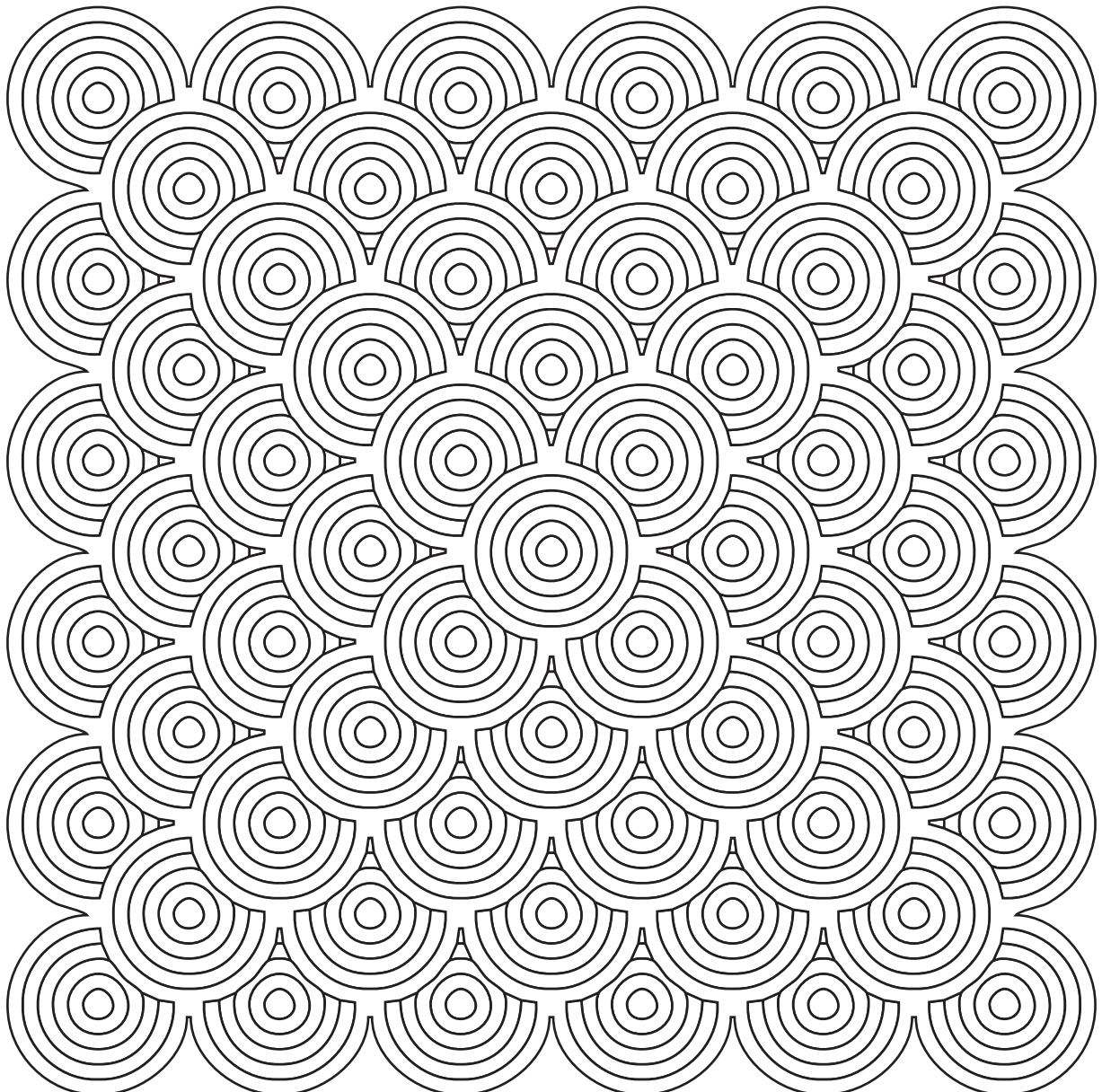

FLOWERS

The left-over letters will spell out something that flowers always need: _____



S	C	S	W	S	U	N	F	L	O	W	E	R	S	K
M	H	A	B	E	E	T	P	B	H	L	A	O	N	C
U	R	I	E	S	C	E	E	U	T	E	T	S	O	O
R	Y	N	D	O	Y	L	T	D	A	A	A	E	G	R
H	S	I	S	R	C	O	A	S	E	F	N	D	A	C
T	A	S	D	E	L	I	L	A	R	E	E	E	R	H
E	N	R	L	B	A	V	S	I	B	R	M	L	D	I
R	T	U	O	U	M	N	C	N	S	P	O	P	P	D
Y	H	D	G	T	E	A	A	O	Y	E	N	H	A	S
P	E	A	I	I	N	C	I	G	B	O	E	I	N	E
B	M	H	R	D	S	I	N	E	A	N	S	N	S	I
E	U	L	A	L	M	R	N	B	B	I	C	I	T	P
E	M	I	M	E	L	F	I	N	E	E	E	A	O	P
S	S	A	T	I	N	A	Z	S	Y	S	N	A	P	O
Y	G	S	A	I	N	U	T	E	P	S	T	A	M	P

- ✿ SUNFLOWERS
- ✿ TUBEROSES
- ✿ URSINIAS
- ✿ ZINNIA
- ✿ PANSY
- ✿ PETALS
- ✿ STEM
- ✿ LEAF
- ✿ SCENT
- ✿ ROSE
- ✿ TALL
- ✿ BEDS
- ✿ BEES
- ✿ BEET
- ✿ ROCK
- ✿ POTS
- ✿ SATIN
- ✿ STAMP



- AFRICANDAISY ✿
- AFRICANVIOLET ✿
- ANEMONES ✿
- BABYSBREATH ✿
- BEGONIAS ✿
- BUDS ✿
- CHRYSANTHEMUMS ✿
- CYCLAMENS ✿
- DAHLIAS ✿
- DAISIES ✿
- DELPHINIA ✿
- MARIGOLDS ✿
- ORCHIDS ✿
- PEONIES ✿
- PETUNIAS ✿
- POPPIES ✿
- PYRETHRUMS ✿
- SNAPDRAGONS ✿

Animals

Move each letter forward one place (A becomes B, etc.) to find twenty-five common animals.

- 1 cnf
- 2 gnqrd
- 3 bzs
- 4 bnu
- 5 rgddo
- 6 khnm
- 7 shfdq
- 8 dkdogzms
- 9 ydaqz
- 10 unke
- 11 enw
- 12 snqsnhrd
- 13 adzq
- 14 rmzjd
- 15 qghmnbdqnr
- 16 zmsdknod
- 17 izftzq
- 18 kdnozqc
- 19 bzldk
- 20 fhqzeed
- 21 ghoononszltr
- 22 lnmjdx
- 23 fnzs
- 24 cddq
- 25 bqnbchkd



A	B	C	D	E	F	G	H	I	J	K	L	M
N	O	P	Q	R	S	T	U	V	W	X	Y	Z

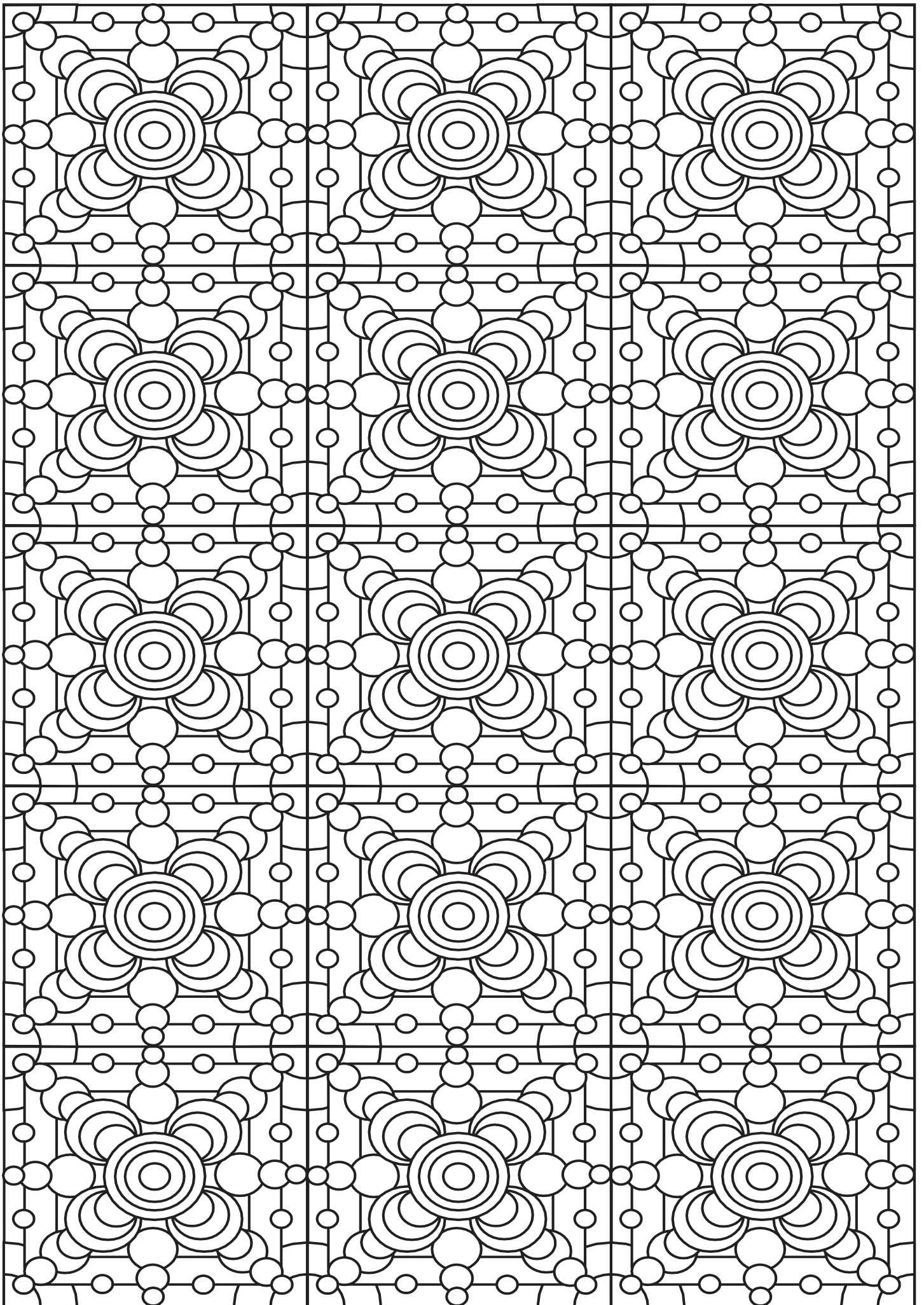

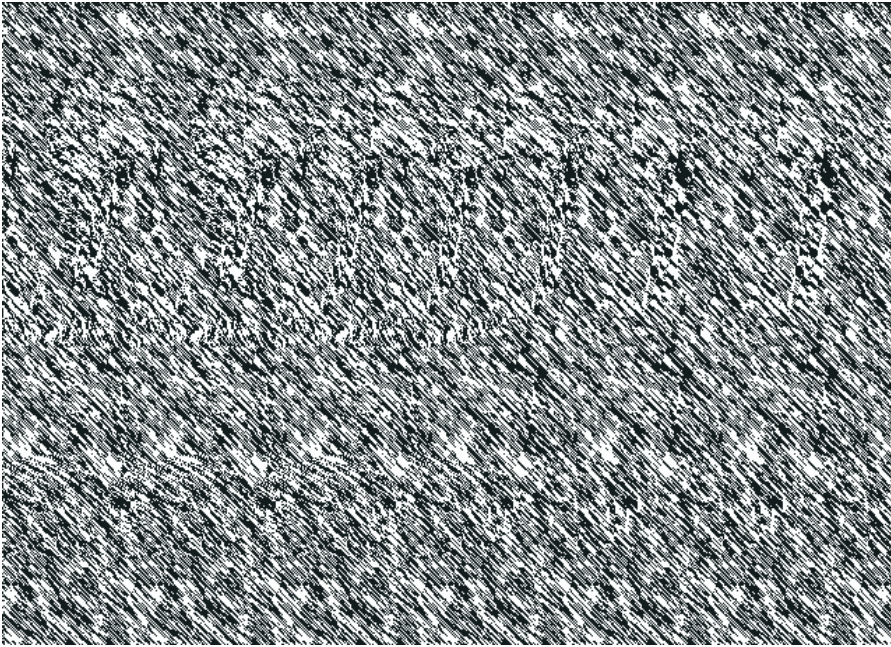

STPBRBOBA
STPBRBOBA
STPBRBOBA

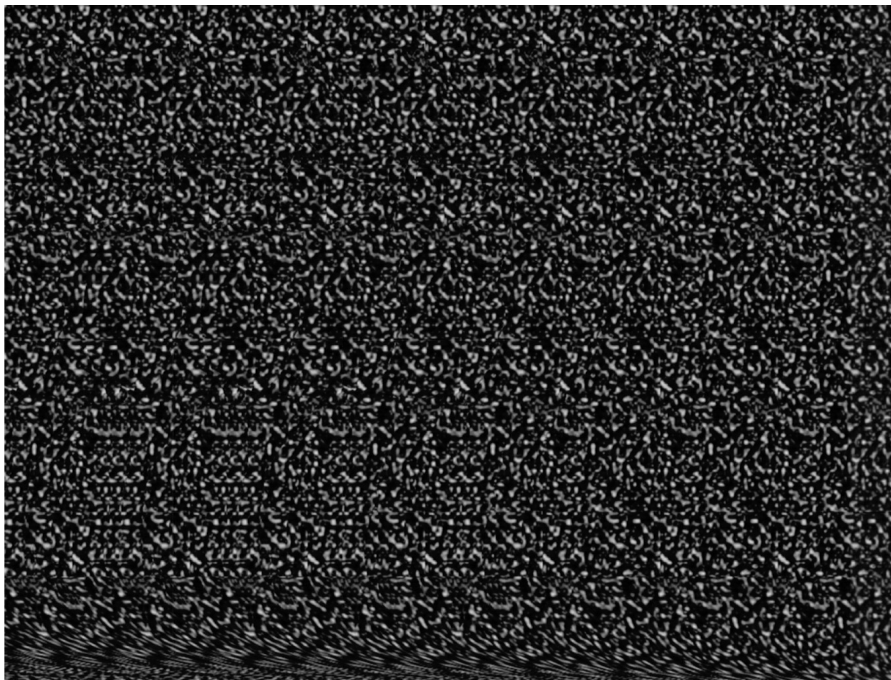
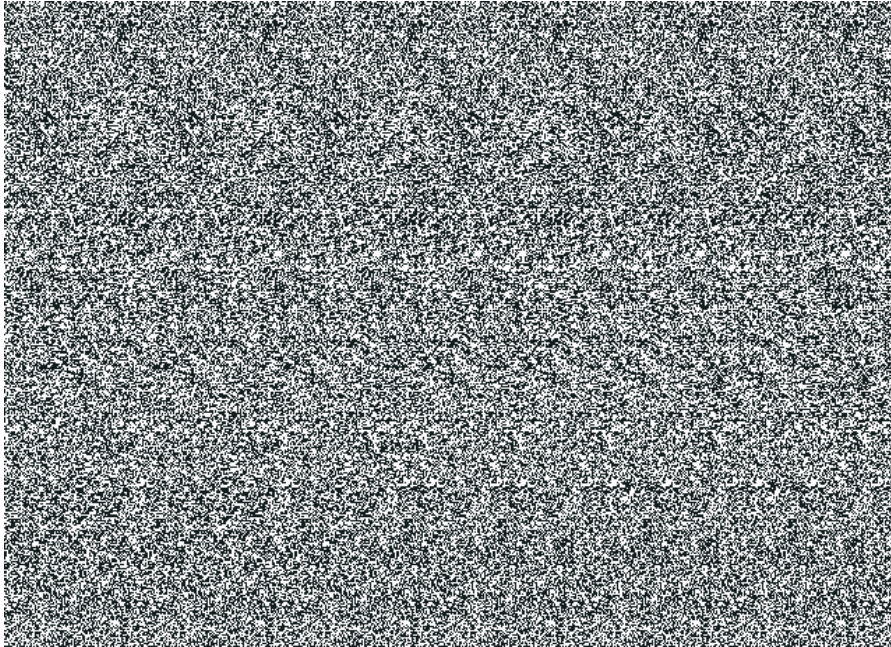

Draw the
hidden
pictures
in the
boxes.



Sudoku - Easy Puzzle 1

6		8		2				4
		5				3		1
	3		7		4	8	9	
		9		1		7		
	4		8				3	9
	6		2	7				5
5		3				2		8
9			1			6		7
7	2			4	8		1	

Sudoku - Easy Puzzle 2

		8		6			1	
5		3		4	8	9	2	
1				3				5
	3		4	9			5	
4			7			8	6	
7	9	5			1	3		
3		9						6
		2		7				
6		7	3		5	2		8

Sudoku - Easy Puzzle 3

	1		9			3	7	
	5		4	2				8
2		8						
5		1					3	6
7			1			5	9	
4		9		3	7	8		
				1	6	2		
	9			5	4	1		7
	7	6	8	9		4		

Sudoku - Easy Puzzle 4

3	2		1		5	7		
9			7			1		
			8		9	4		5
		6		7		8	5	
	8						7	9
5		3		8	2			
	1	9	6					
		2	4		8	5	6	
6	4			1			3	8

Sudoku - Easy Puzzle 5

9	8		7					3
6			4	8				5
		4		9		1	8	
1					7	5	2	8
	5	7		3				
2		9	6					
	7	6	3		9			4
		8		6		2	3	
	1			7	4			9



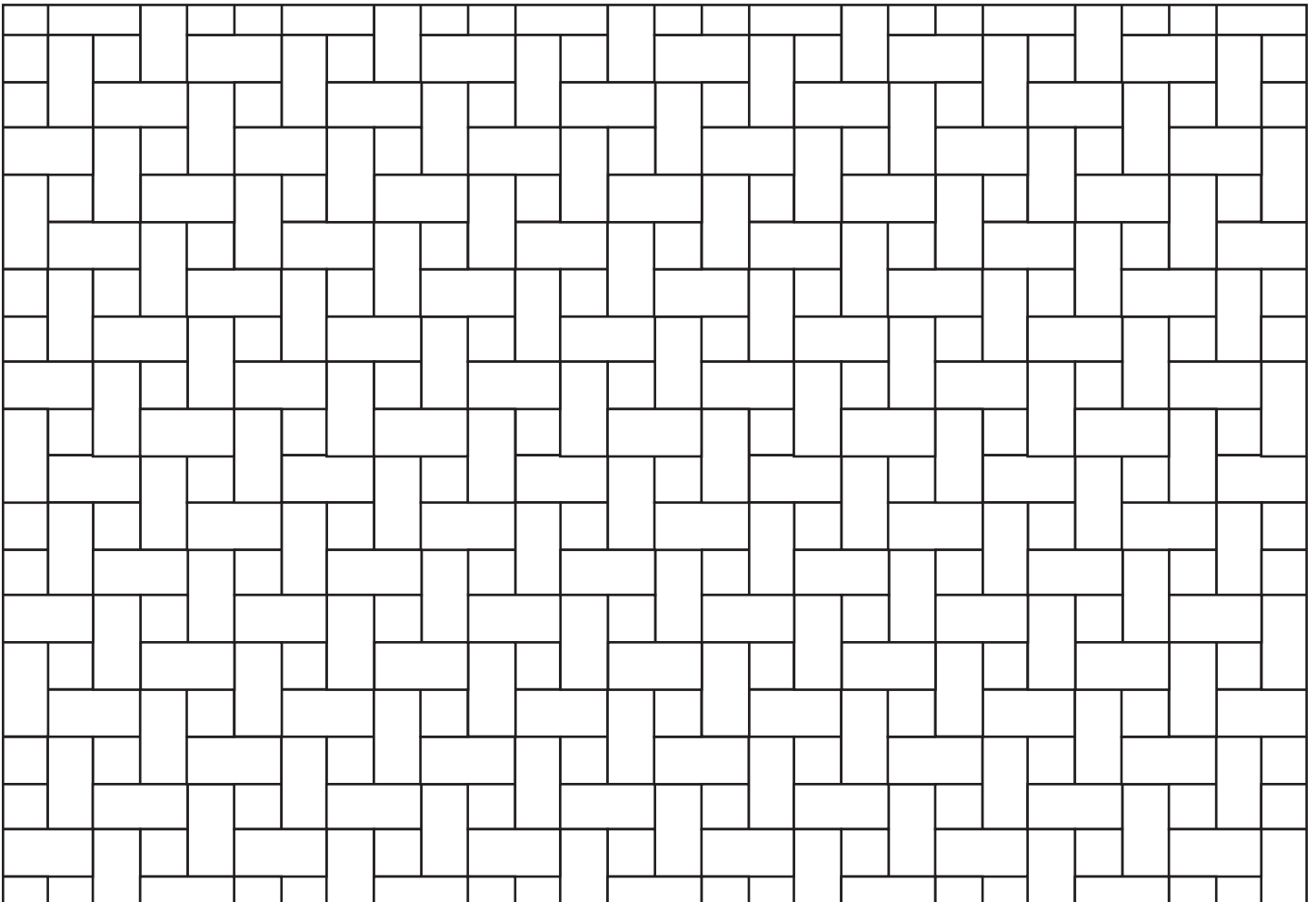
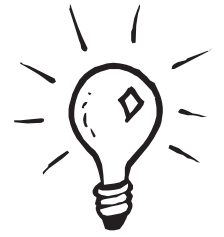
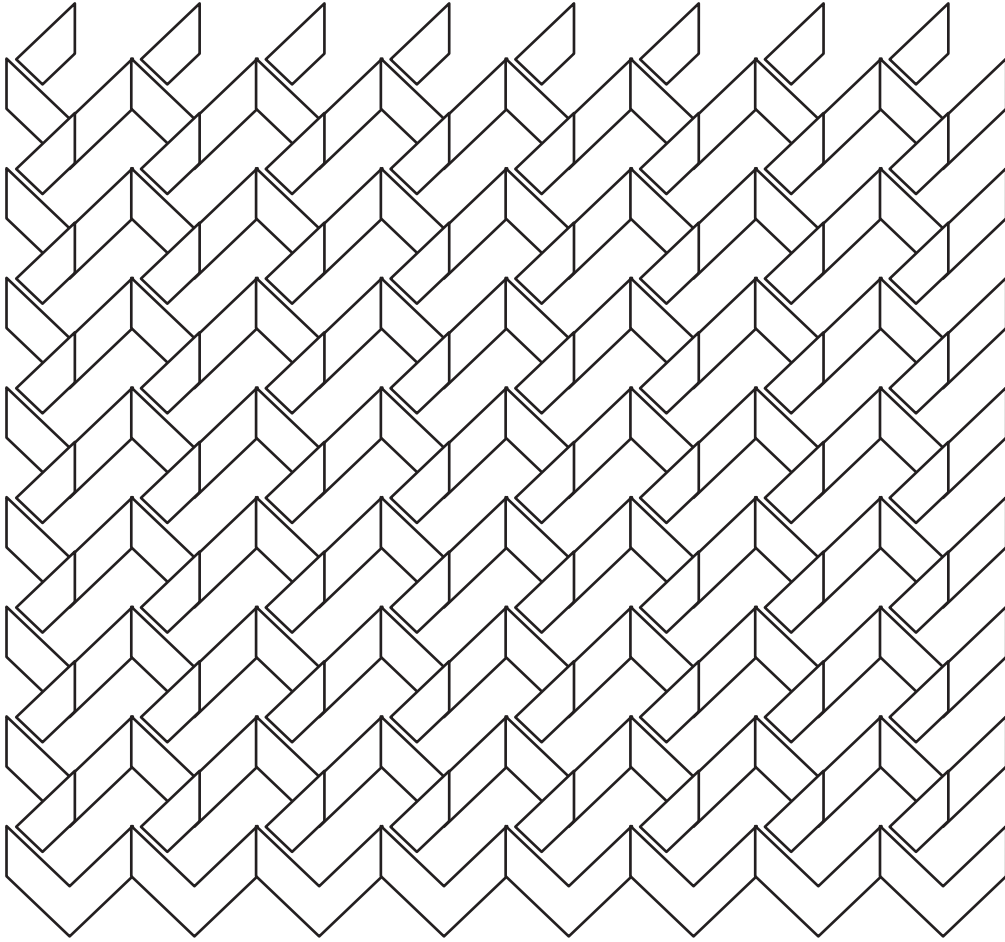

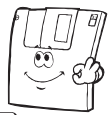

S T N E M T S U J D A H E A D
 E V A L S D N A H N P R O M M
 V H R R C E S L O T A T K O Y
 I C C E I E R D S W I S S R R
 R L O A R P E A T A C T I D O
 D I W D C S R F W R C N D C T
 D E A R U T O O E D F H G O C
 R N G N I S S E C O R P I M E
 A T E R T T N A R E S A A P R
 H M S Y S T E M F M S A H U I
 C A L C U L A T O R E S V T D
 M C O F I T D O R C I M O E A
 R P W F I E A S M A R G O R P
 A U T O M A T I C A L L Y R R
 M E N I H C A M O N I T O R Y

The left-over letters will spell something that every computer needs: -----

> I N F O R M A T I O N
 > P R O C E S S I N G
 > C A L C U L A T O R
 > M A C H I N E
 > S Y S T E M
 > D A T A
 > A U T O M A T I C A L L Y
 > C P U
 > P R O C E S S O R
 > C O M P U T E R
 > C I R C U I T
 > H A R D W A R E
 > S O F T W A R E
 > P R O G R A M S
 > C A C H E
 > D I S K

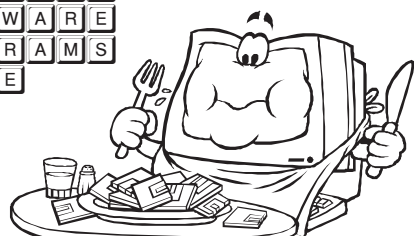

> H A R D D R I V E
 > M O N I T O R
 > A D J U S T M E N T S
 > D I R E C T O R Y
 > S C R E E N
 > M E M O R Y
 > S P E E D
 > C D R O M
 > R E A D
 > W R I T E
 > S A V E
 > F I L E
 > C H I P
 > M I C R O
 > H O S T
 > S L A V E

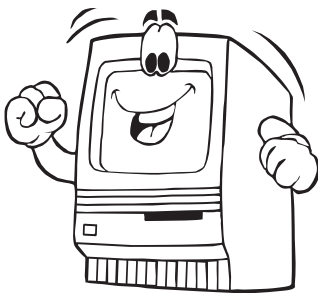

> C L I E N T
 > N O D E
 > W A I T
 > O F F
 > S L O W
 > F A S T
 > S L O T
 > R A M
 > R O M
 > H E A D
 > H A N D S
 > W A G E S
 > M O S T
 > P A D

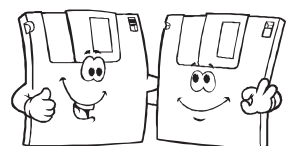

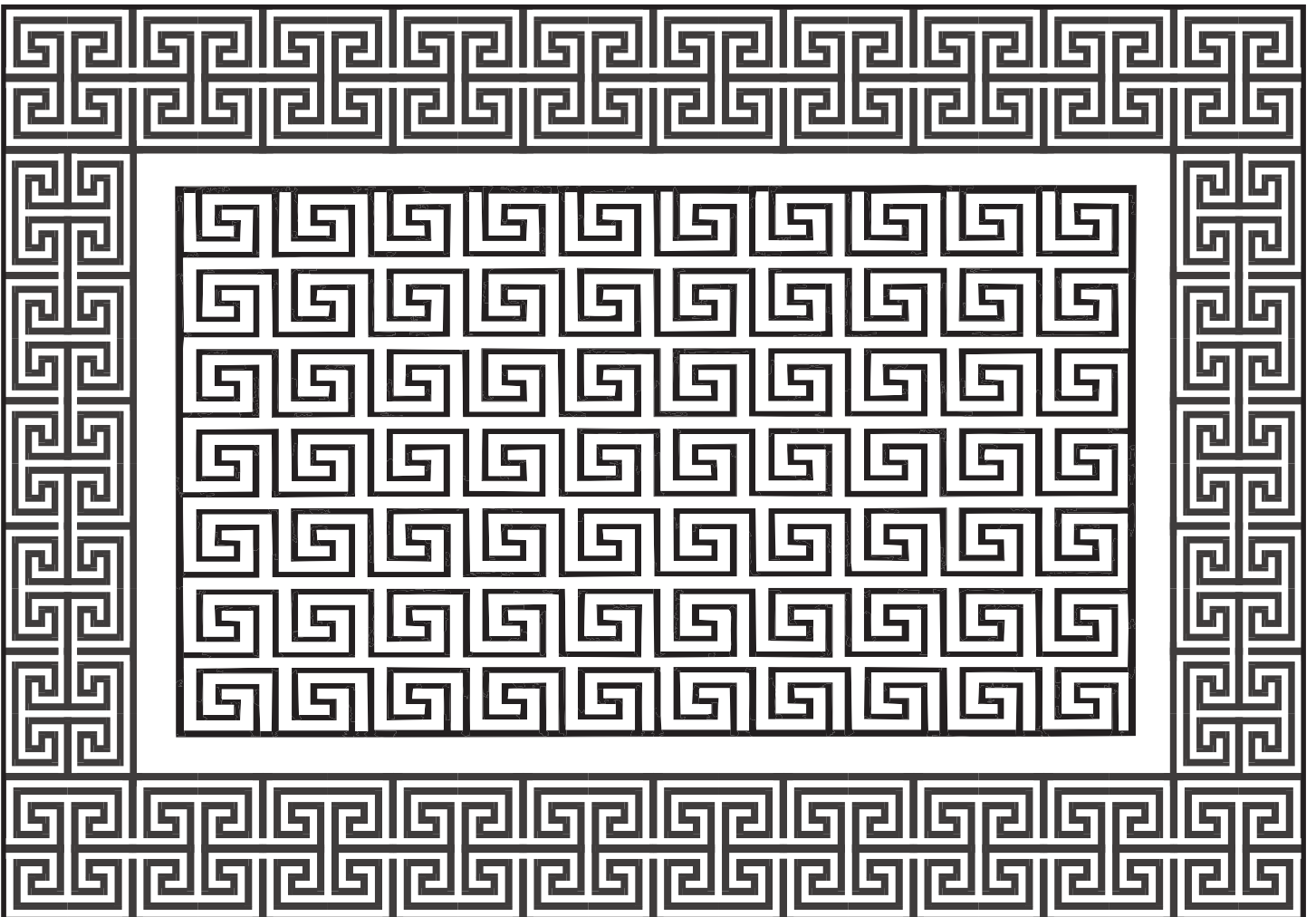
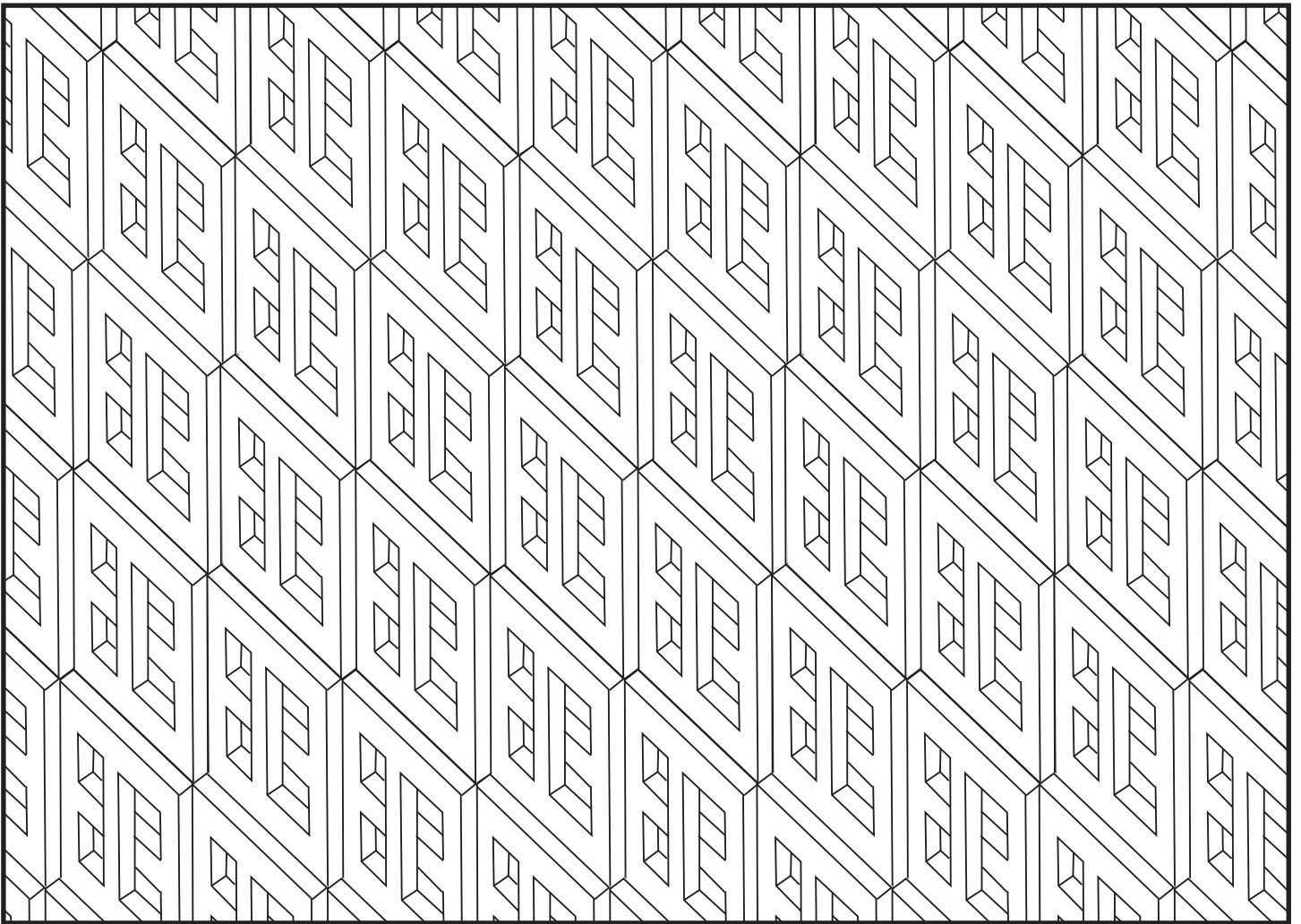

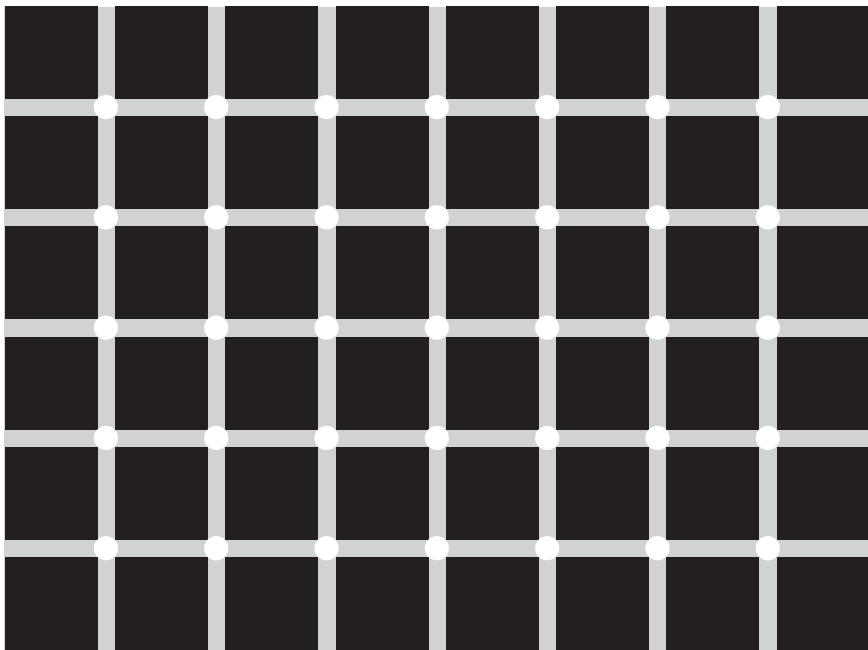

There are only white circles at the intersections.



Two sticks?

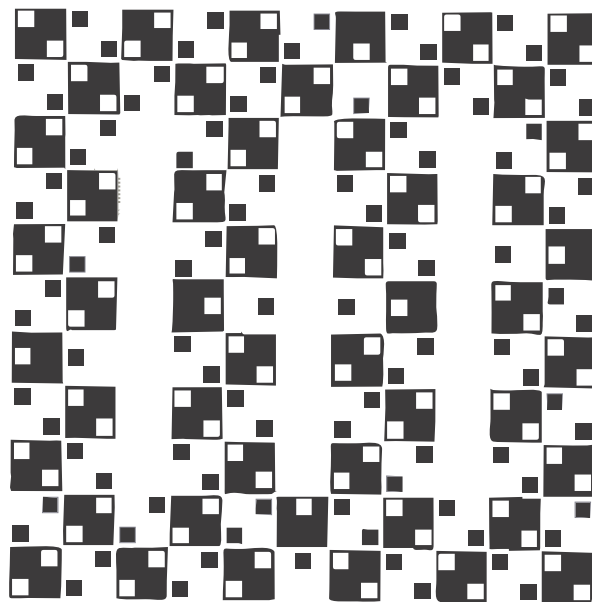
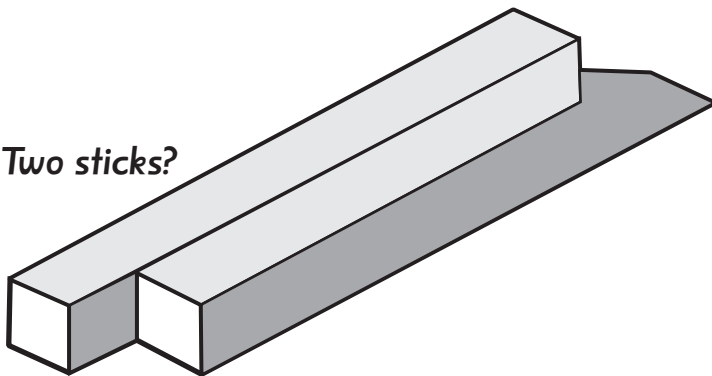

There are no curved lines in these figures.

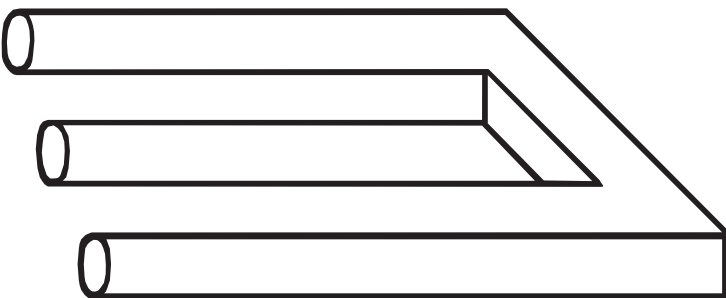

Three prongs?

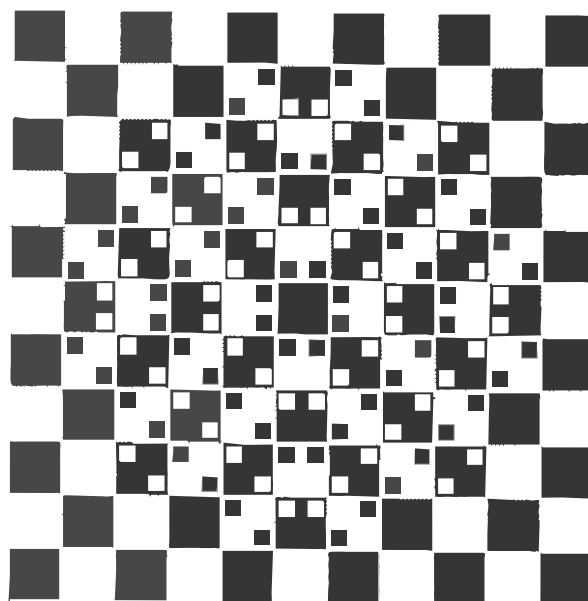

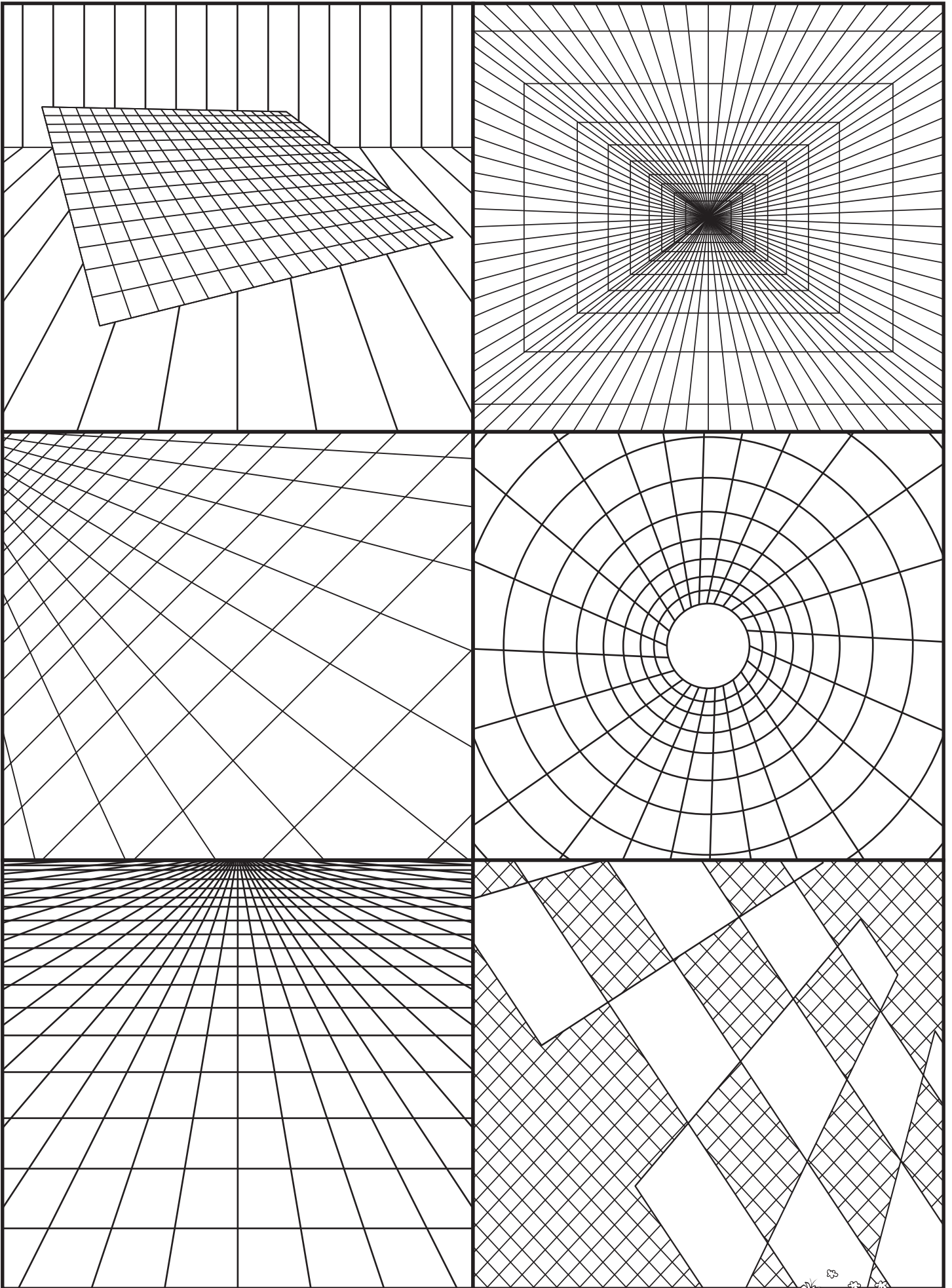

Explore these designs with colour.



Try to colour these

OPTICAL ILLUSIONS

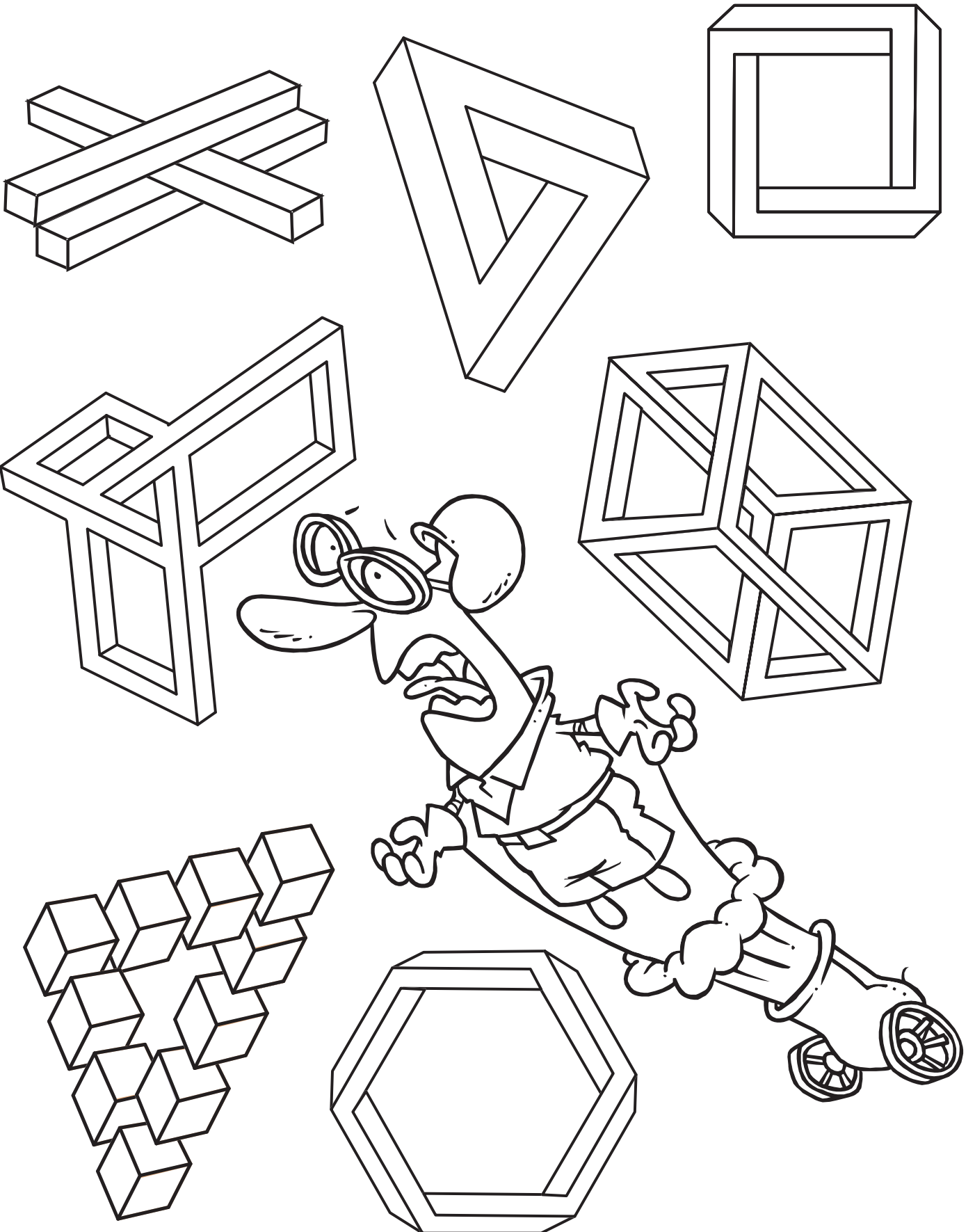

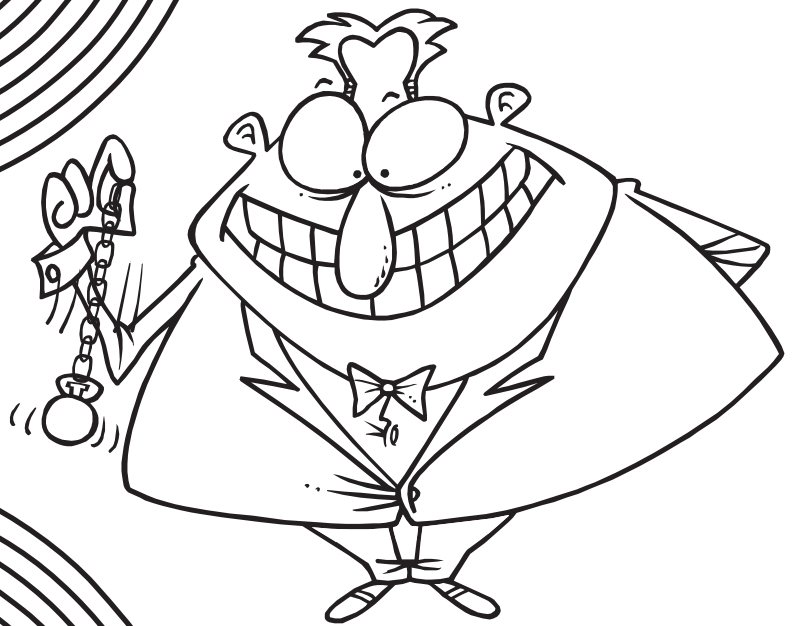
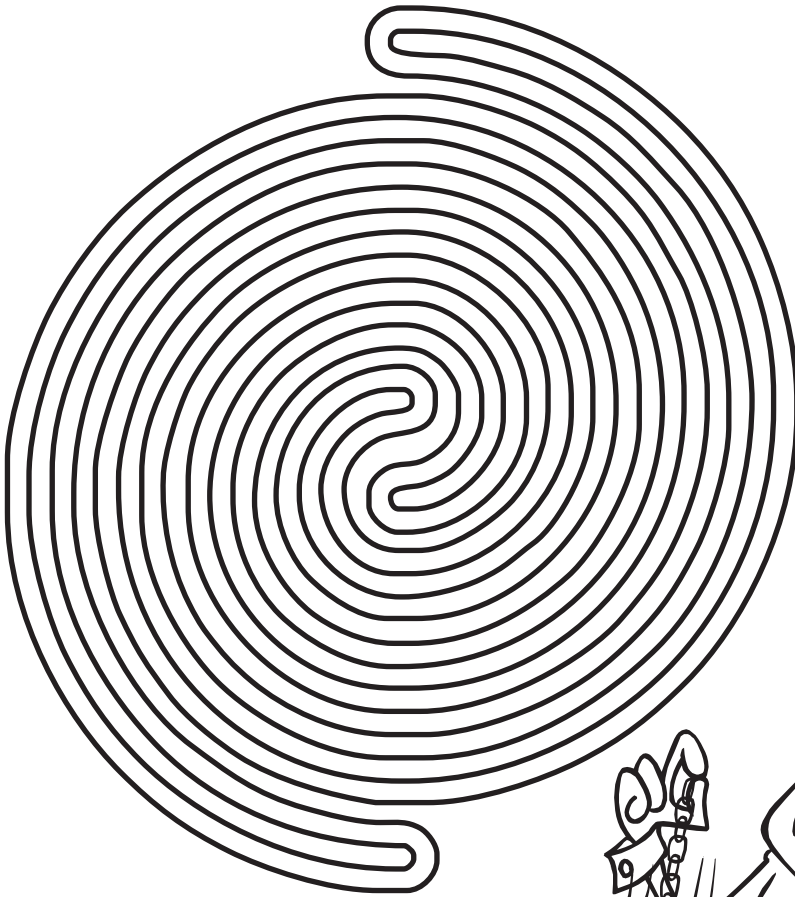

Colour these spirals for a surprise.

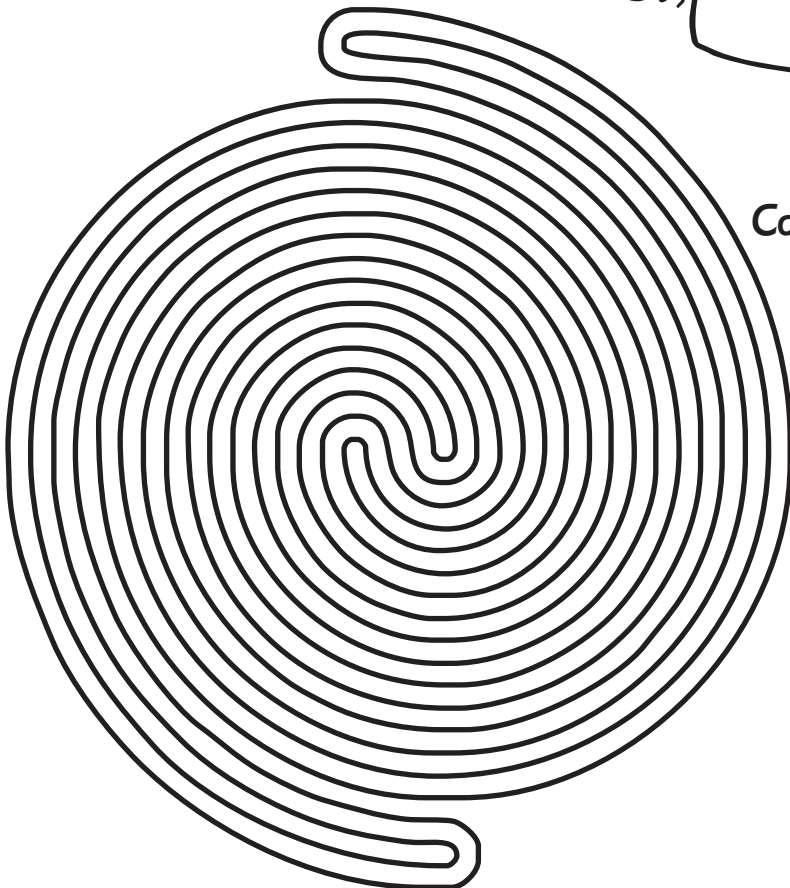

Colour pathways through these interesting Roman mazes.

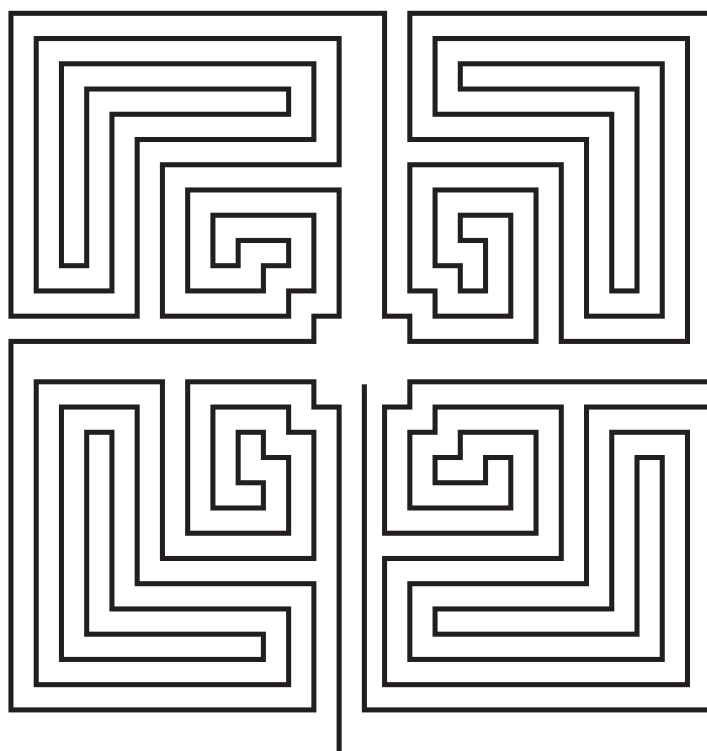
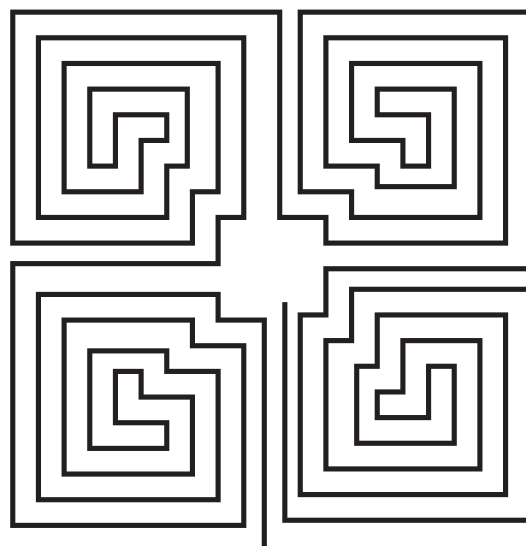
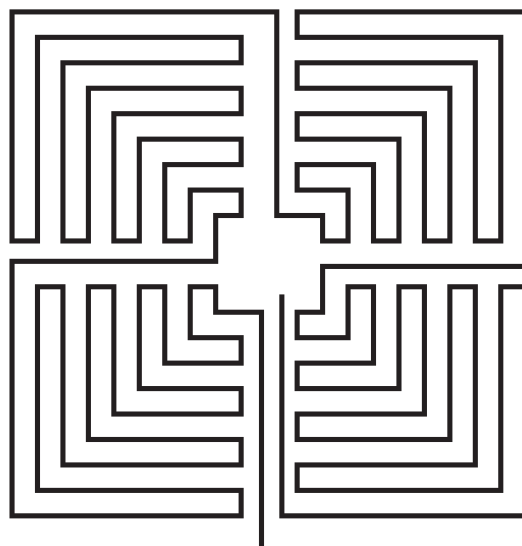
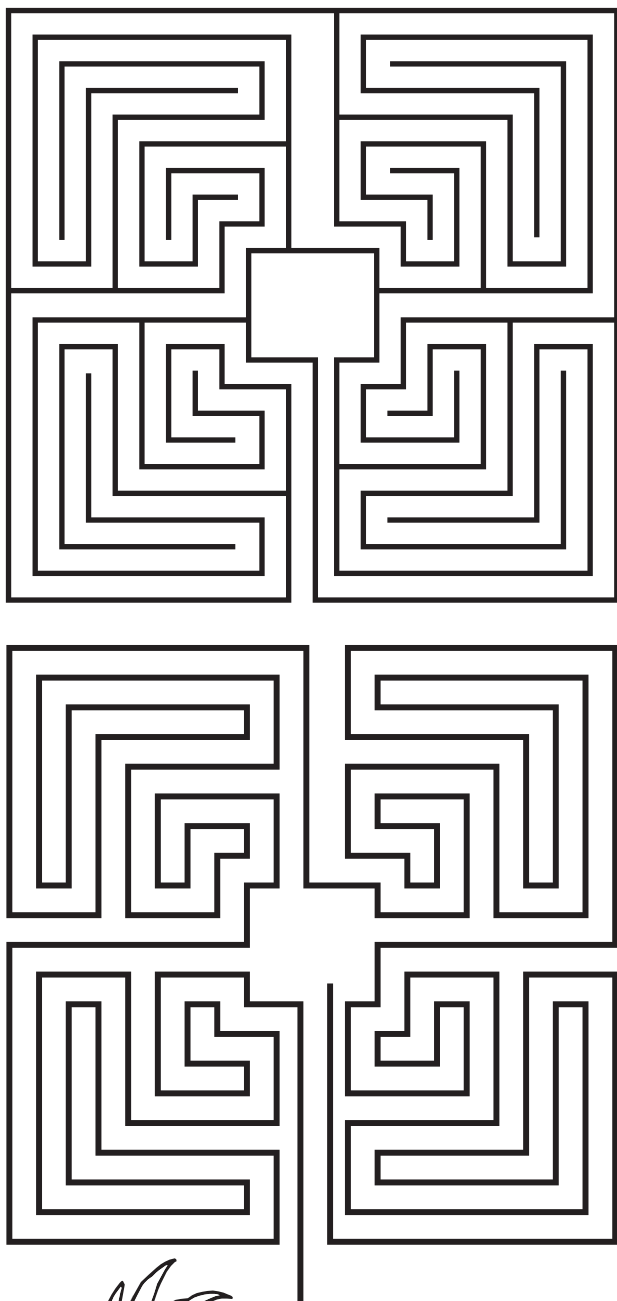

Use the ideas below
to produce your own
design on the big octagon.
Use a ruler and colour it carefully.



1

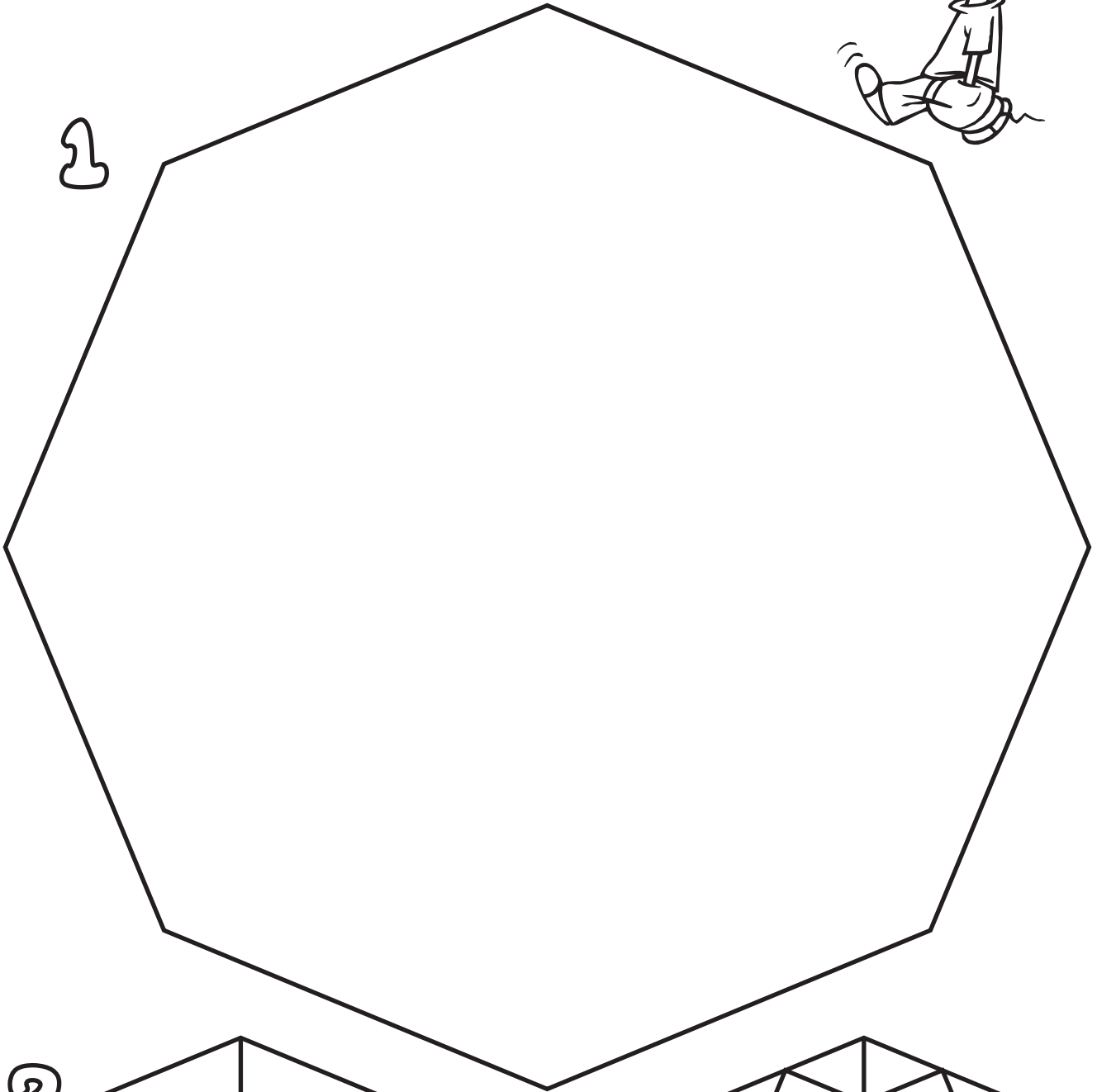

2

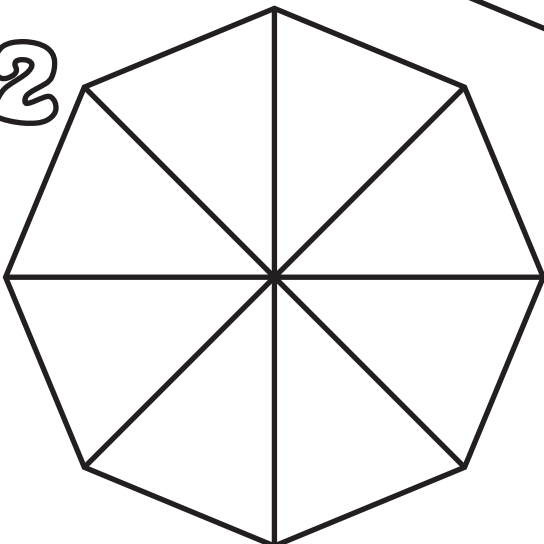

3

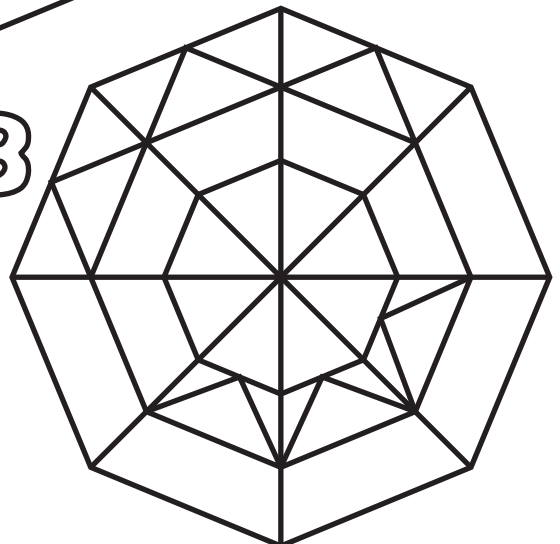

USE COLOUR TO MODIFY THIS BLANK DISPLAY TO MAKE YOUR OWN LETTERS.
YOU COULD WRITE YOUR NAME AND ADDRESS OR A NOTE TO SOMEBODY.

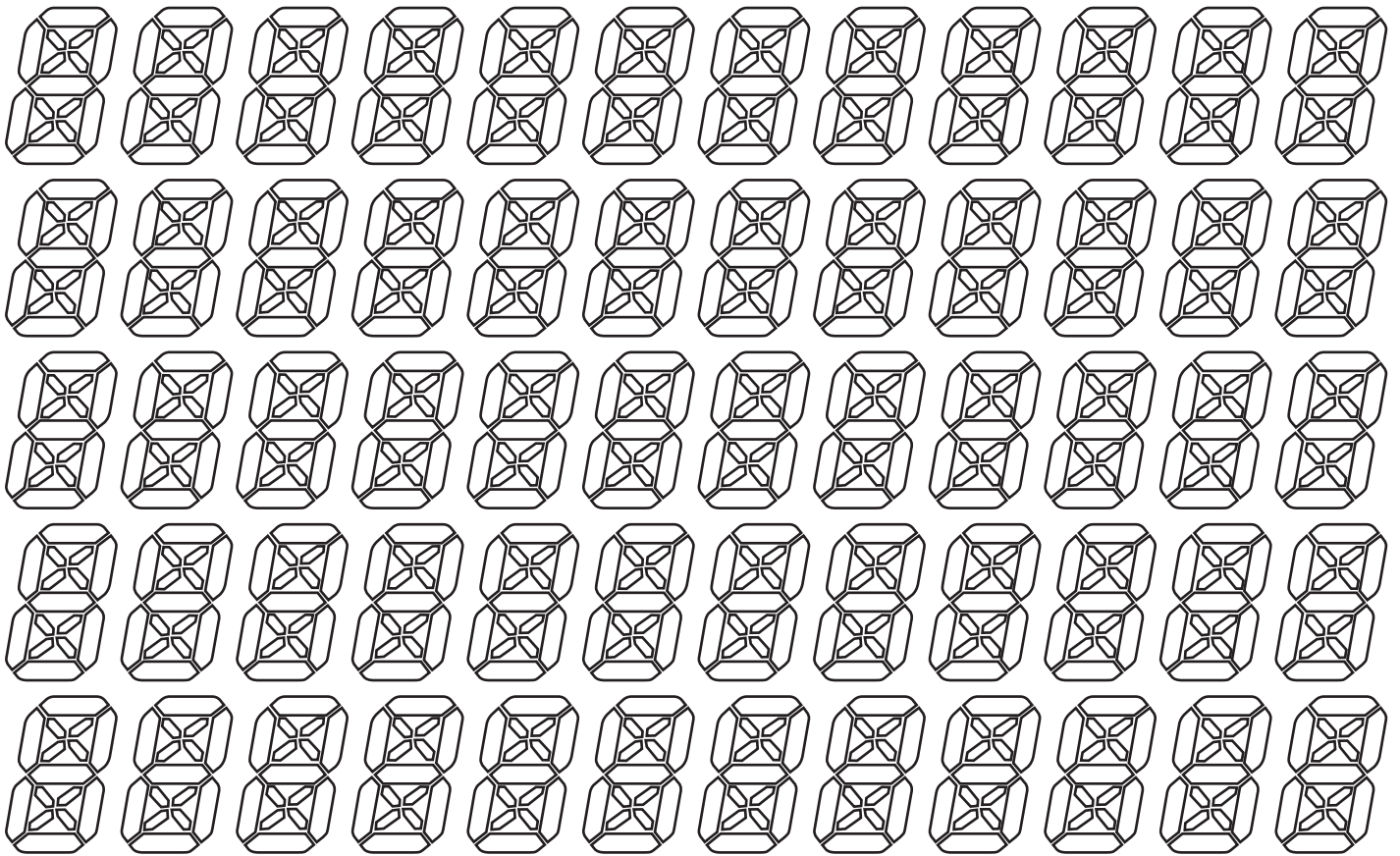

12 squares to explore.

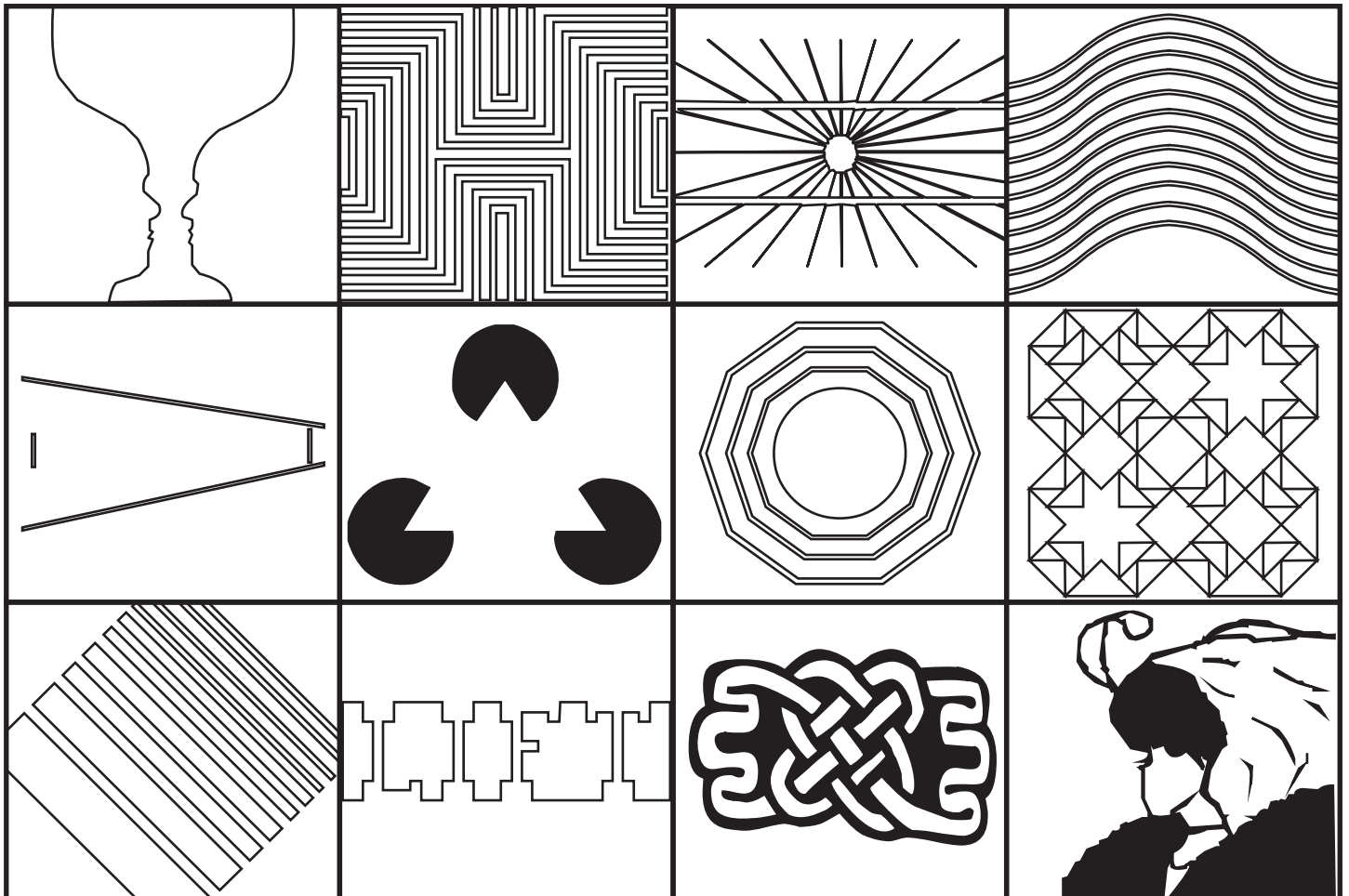

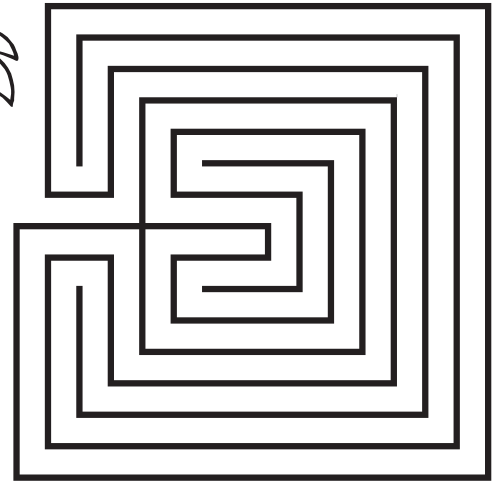
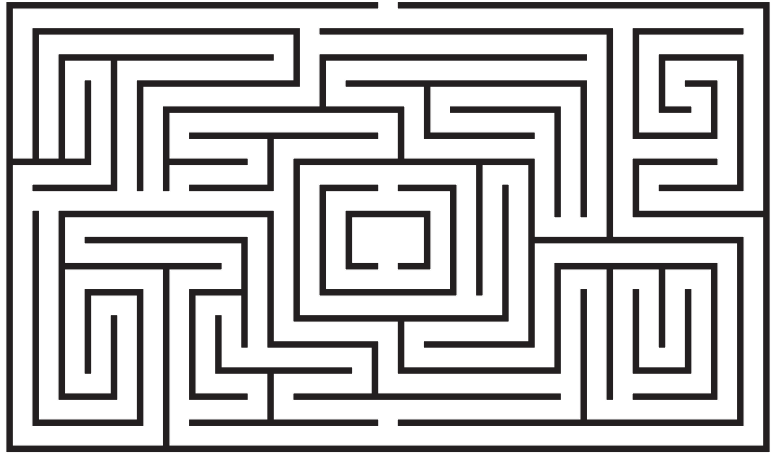
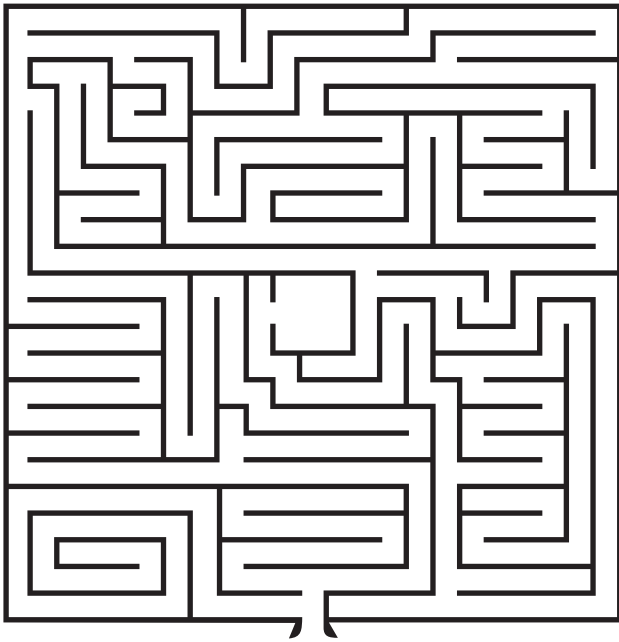

*Fly around these mazes.
Use colour to explore them.*

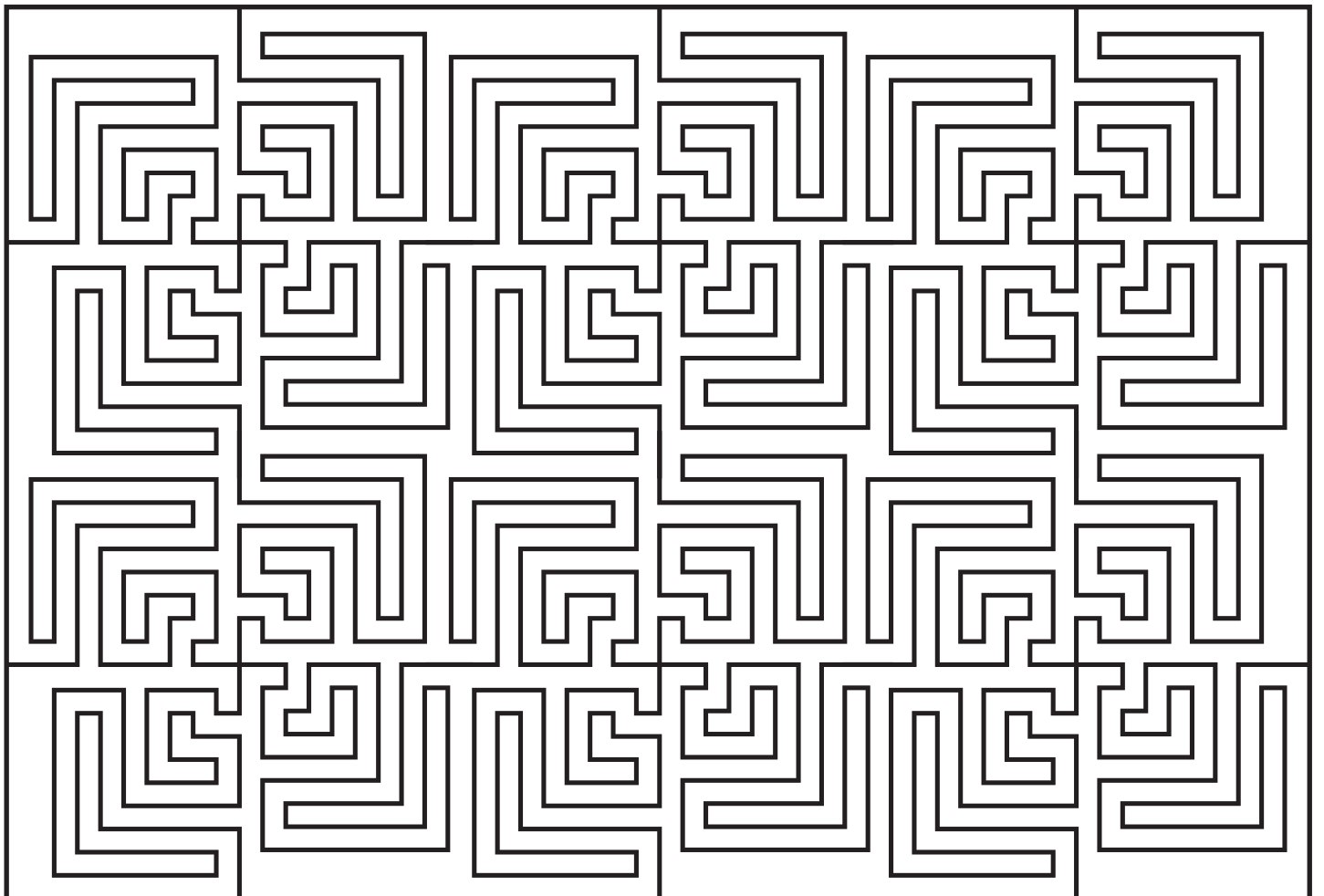

THAUMATROPE

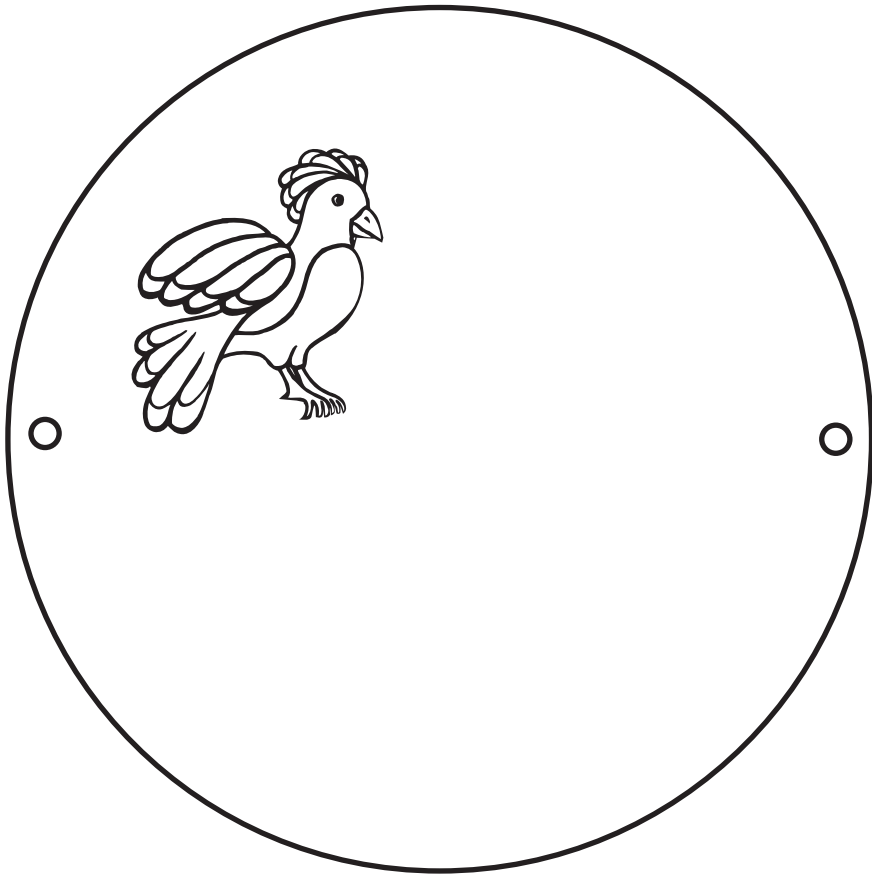

☼ Colour and cut out the two disks.

☼ Glue them back to back onto some cardboard (or photocopy directly onto cardboard).

☼ Punch out some holes where shown, and thread some pieces of string through them.

☼ Twist up the string so that the disk twirls.

☼ The bird should end up landing at the bird house.

☼ Try it with other images.

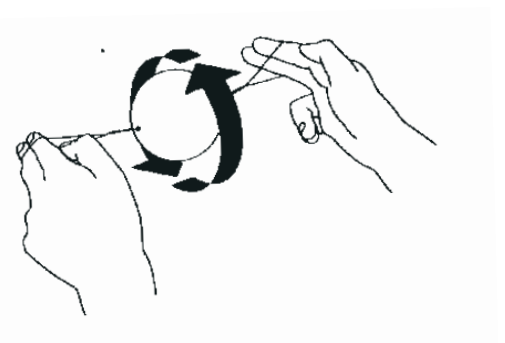
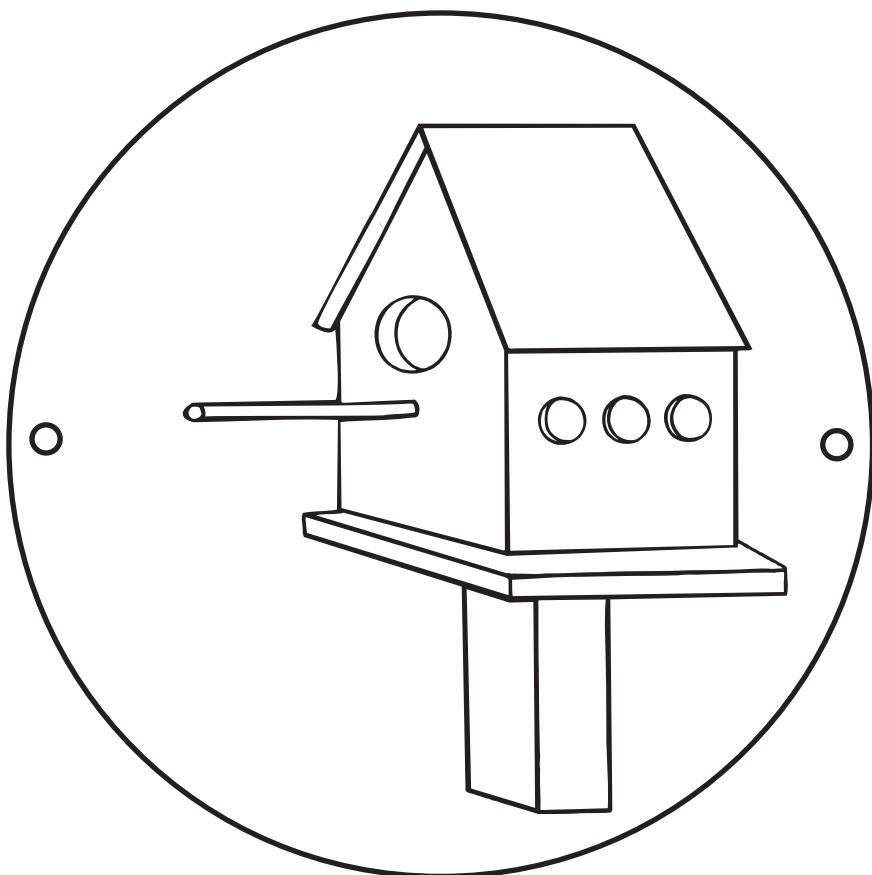

WEATHER PATTERNS

N O N E M O N E H P B W E D M
 O H A I L A P C E R A Y R L B
 I T E T D T W O A H D Y A E L
 T E P A M M O L T N I C I S O
 A M E O C O N D I T I O N S W
 T P V S H S S W O G C G F D Y
 I E A P A P E P O W A T A U C
 P R W O R H W L H L N I L O N
 I A T R T E O D E E D F L L E
 C T A D A R N R N M R U A C M
 E U E T O I A A G O E E O L E
 R R H E W C W A R M I N G L L
 P E T P E F L O O D H O T N C
 R E U S T F E N I H S N U S N
 M D R O U G H T H U N D E R I



- | | | |
|---|-------------------------------------|--------------------------------|
| <input type="checkbox"/> WEATHER | <input type="checkbox"/> ELEMENTS | <input type="checkbox"/> BLOWY |
| <input type="checkbox"/> ATMOSPHERIC | <input type="checkbox"/> HEATWAVE | <input type="checkbox"/> CLOUD |
| <input type="checkbox"/> CONDITIONS | <input type="checkbox"/> HOT | <input type="checkbox"/> CALM |
| <input type="checkbox"/> UPWIND | <input type="checkbox"/> INCLEMENCY | <input type="checkbox"/> DRY |
| <input type="checkbox"/> WINDY | <input type="checkbox"/> SUNSHINE | <input type="checkbox"/> WET |
| <input type="checkbox"/> TEMPERATURE | <input type="checkbox"/> THAW | <input type="checkbox"/> CARE |
| <input type="checkbox"/> METEOROLOGICAL | <input type="checkbox"/> WARMING | <input type="checkbox"/> HEAT |
| <input type="checkbox"/> CLOUDS | <input type="checkbox"/> FLOOD | <input type="checkbox"/> CHART |
| <input type="checkbox"/> PRECIPITATION | <input type="checkbox"/> HAIL | <input type="checkbox"/> MAP |
| <input type="checkbox"/> PHENOMENON | <input type="checkbox"/> GALE | <input type="checkbox"/> FLAG |
| <input type="checkbox"/> ATMOSPHERE | <input type="checkbox"/> SNOW | <input type="checkbox"/> WANE |
| <input type="checkbox"/> BAD | <input type="checkbox"/> DROPS | <input type="checkbox"/> LESS |
| <input type="checkbox"/> COLD | <input type="checkbox"/> DROUGHT | <input type="checkbox"/> MOVE |
| <input type="checkbox"/> DOWNFALL | <input type="checkbox"/> THUNDER | <input type="checkbox"/> DEW |
| <input type="checkbox"/> RAINFALL | | |

The left-over letters will spell out one of the biggest weather problems: _____

Explore these interesting designs with some colour.

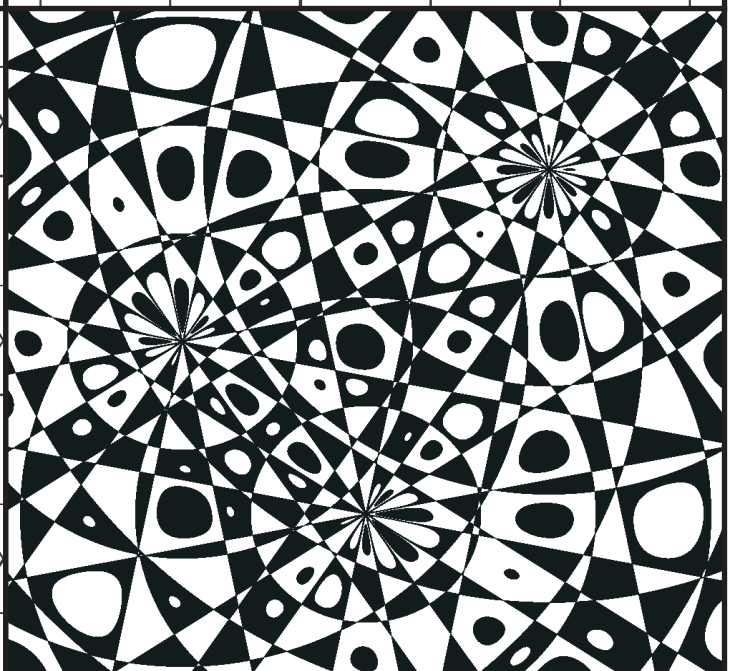
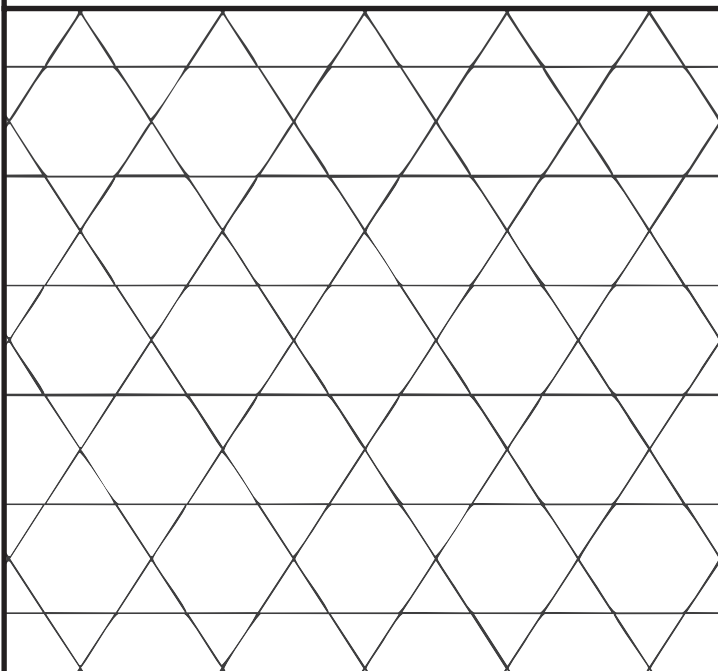
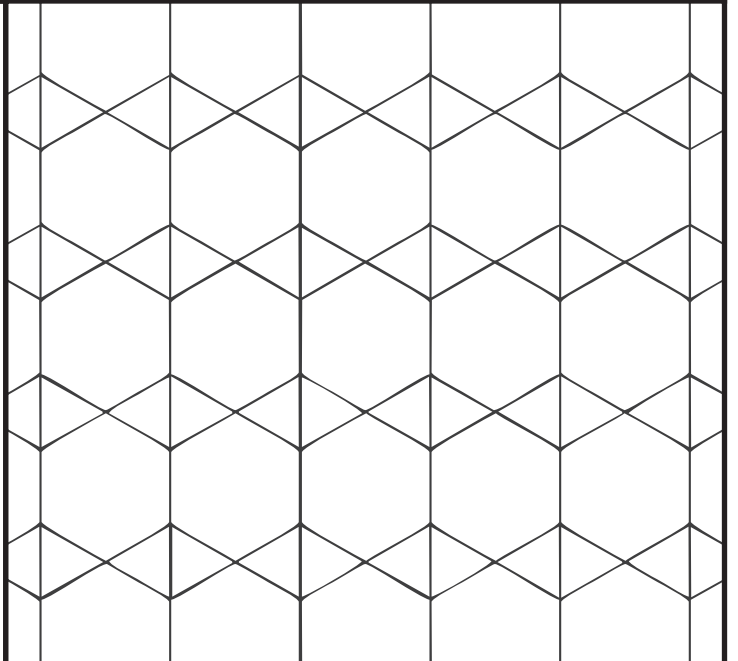
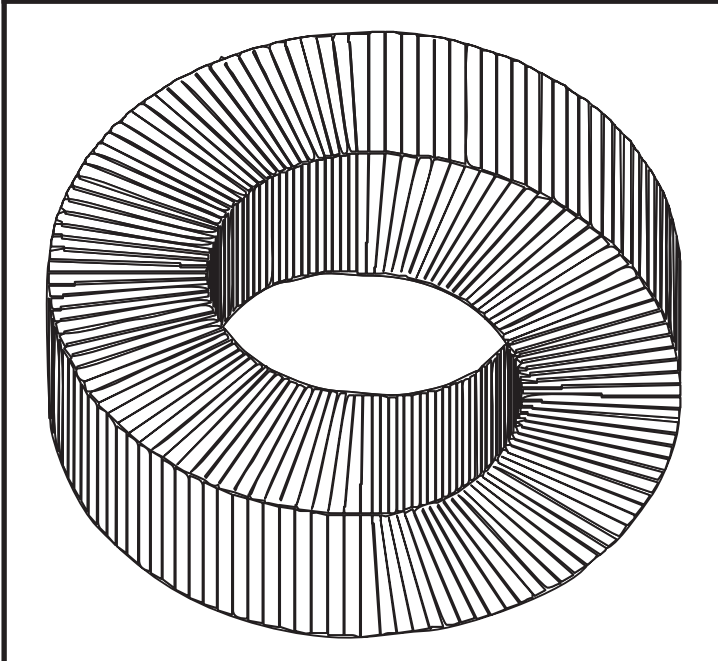
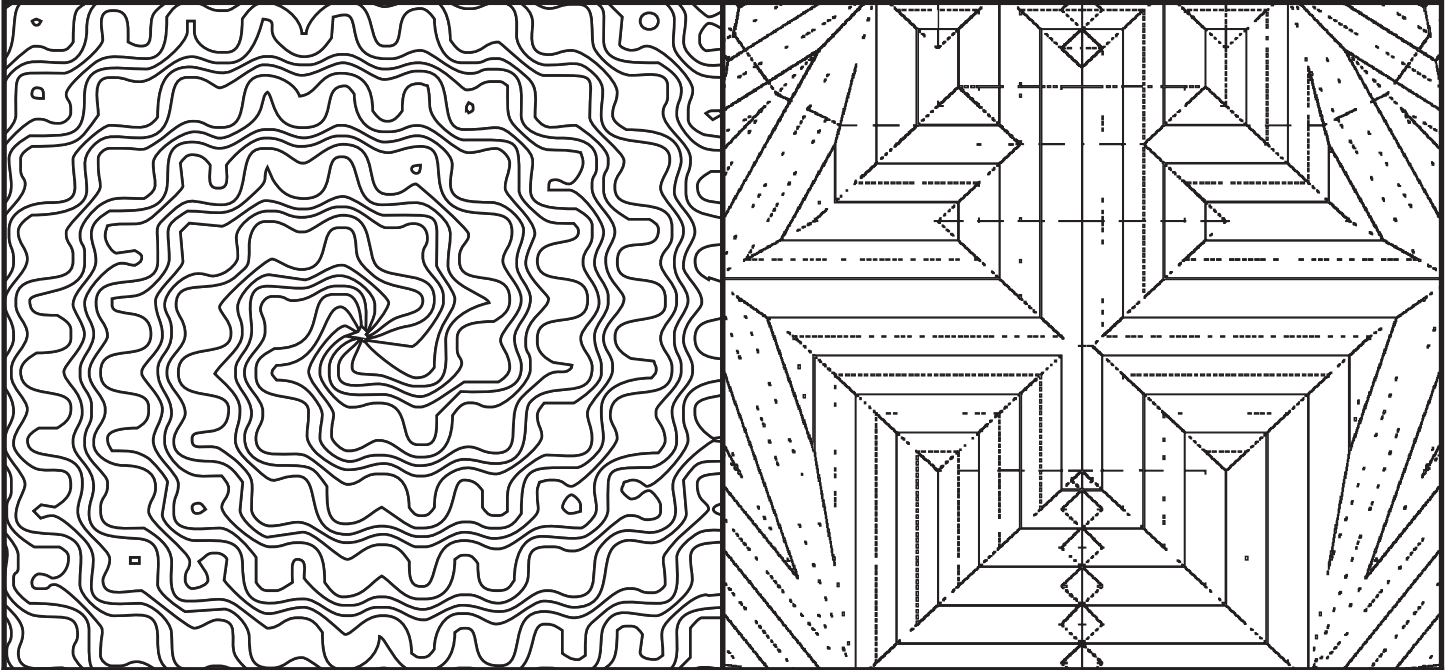

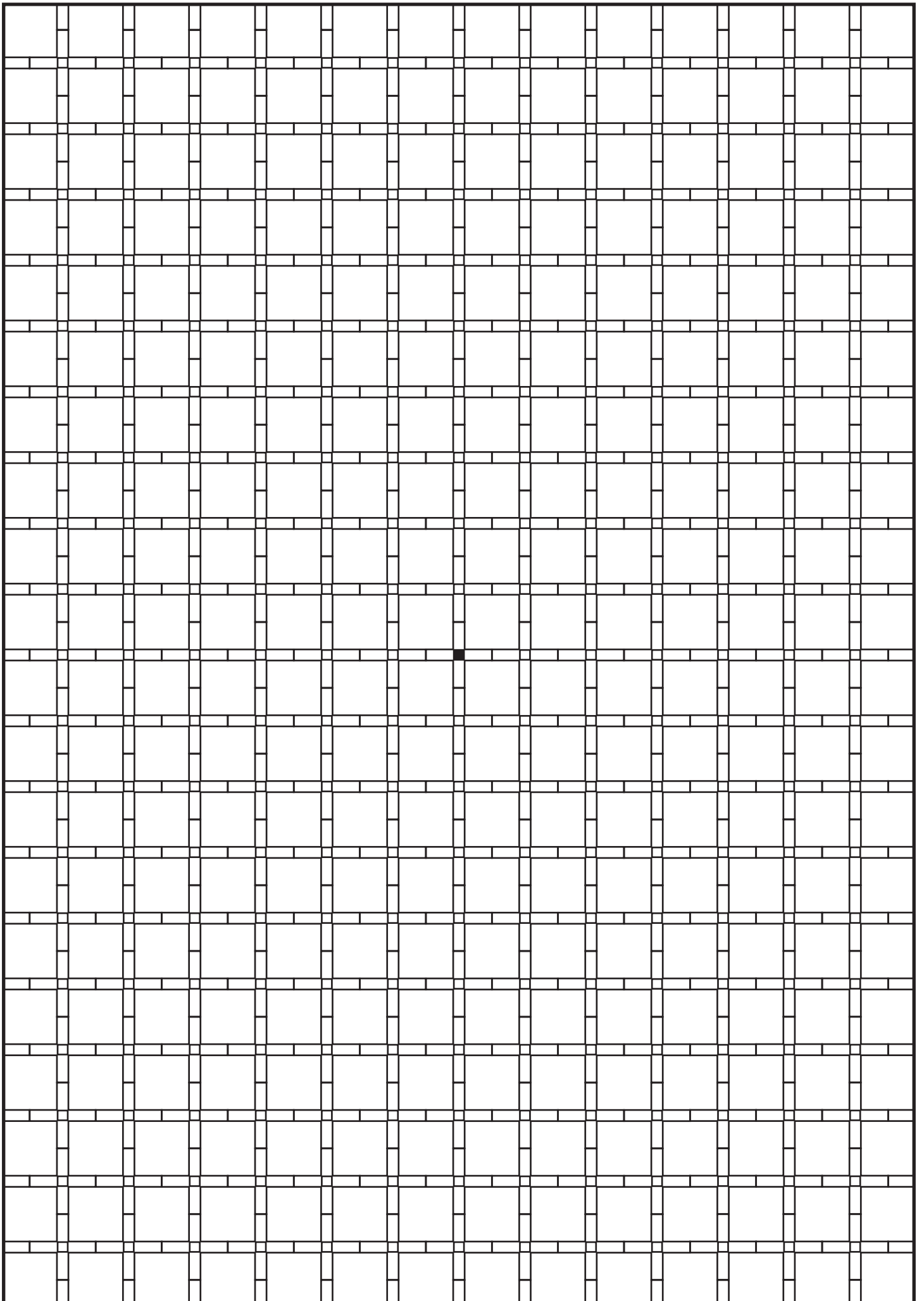

The

HEXACUBE

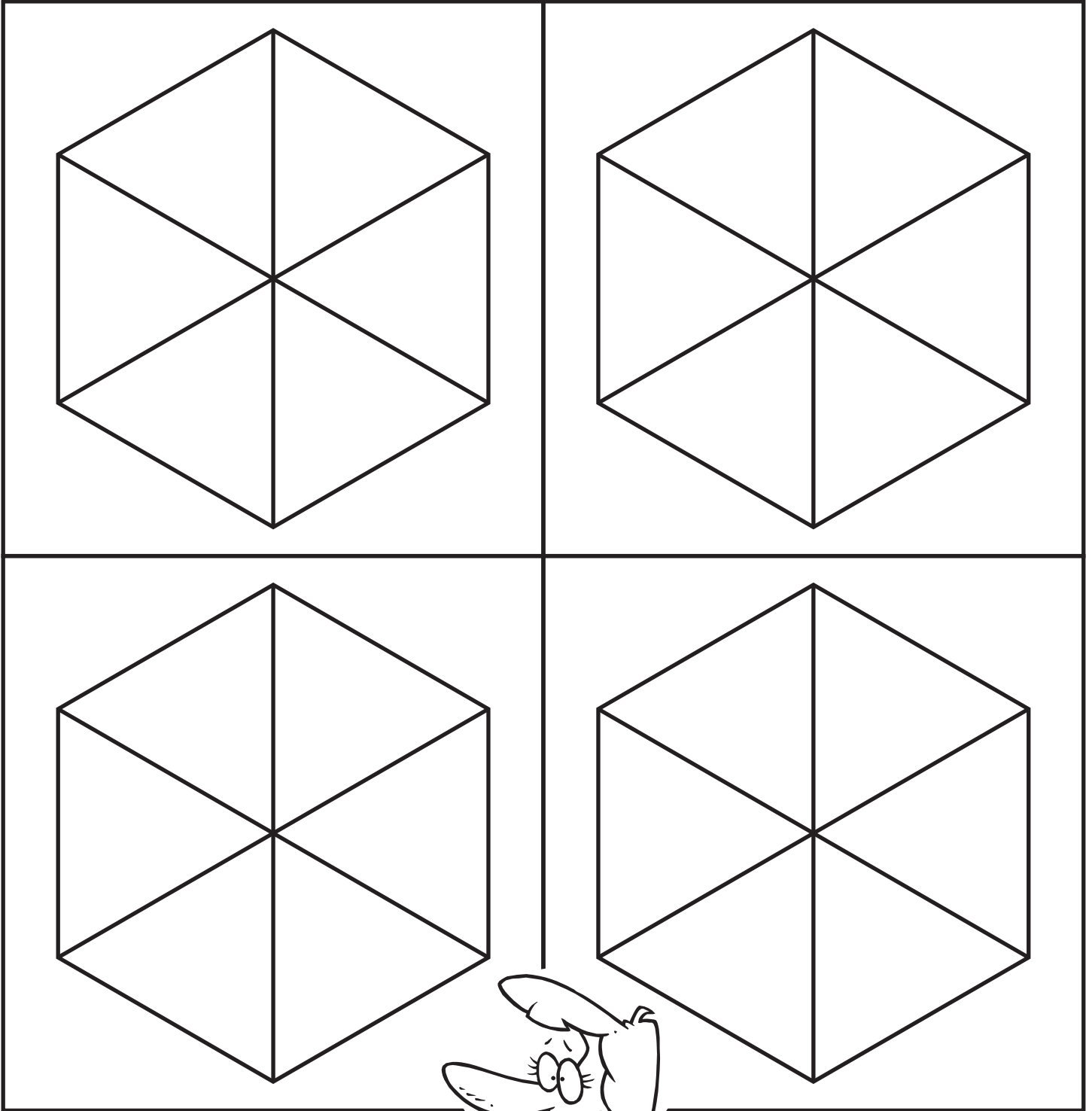

This shape is half-way between a hexagon and a cube in perspective. Use colour to show how different it can be.

- CHIMES
- HARP
- VIOLIN
- DRUMS
- CASTANETS
- BASSOON
- HARMONICA
- TRUMPET
- CLARINET
- PANPIPES
- RECORDER
- TIN WHISTLE
- FLUTE
- VIOLA
- OBOE
- GLOCKENSPIEL
- GUITAR
- XYLOPHONE
- SAXOPHONE
- BAGPIPES
- CYMBALS
- BUGLE
- TROMBONE
- BELLS
- PICCOLO
- SITAR
- ORGAN
- UKULELE
- TUBA
- PIANO
- MANDOLIN
- BANJO
- TAMBOURINE
- TYMPANI
- FRENCHHORN
- KEYBOARD
- CELLO
- WIND
- STRINGS
- ORCHESTRA
- BRASS
- RHYTHM
- GROUP
- SEMITONE
- TEMPO
- MELODY
- BLUES
- POP
- ROCK
- METAL
- FORTE
- MELLOW
- SOUND
- MUSIC
- PLAYERS
- DYNAMICS
- CONCERT
- PERCUSSION
- CLASSICS



MUSICAL INSTRUMENTS

T B G J X D V F B C V G L A S S I C S Y
 R I R M T Y H V N O I S S U C R E P A B
 E W O A J N L I L V O M R O C K C N B U
 C E U N S A F O D X L Q H E R A T I U G
 N N P D A M G L P R A H L T S G C M T L
 O I E O X I O I U H U L J T Y H A E R E
 C R X L O C P N B T O M A W I H D T O N
 F U P I P S D U P U E N S M P G R A R O
 W O P N H T R U M P E T E N I R A L C T
 O B R A O J N A B T S S L L E B O E H I
 L M A T N B A S S O O N E O B O B I E M
 L A G M E P C I S U M E L O D Y Y P S E
 E T I N W H I S T L E S U F K J E S T S
 M L C T T M N P V E X Y K W X S K N R I
 Y T R E D R O C E R B L U E S W H E A N
 A J M N S R M Z X S E P I P G A B K C A
 R P I S T T R O M B O N E O L O C C I P
 O W A S I T A R O P O E S N A G R O L M
 F R E N C H H O R N Z W C Y M B A L S Y
 B P L A Y E R S D N U O S T R I N G S T

Spiraling out of control

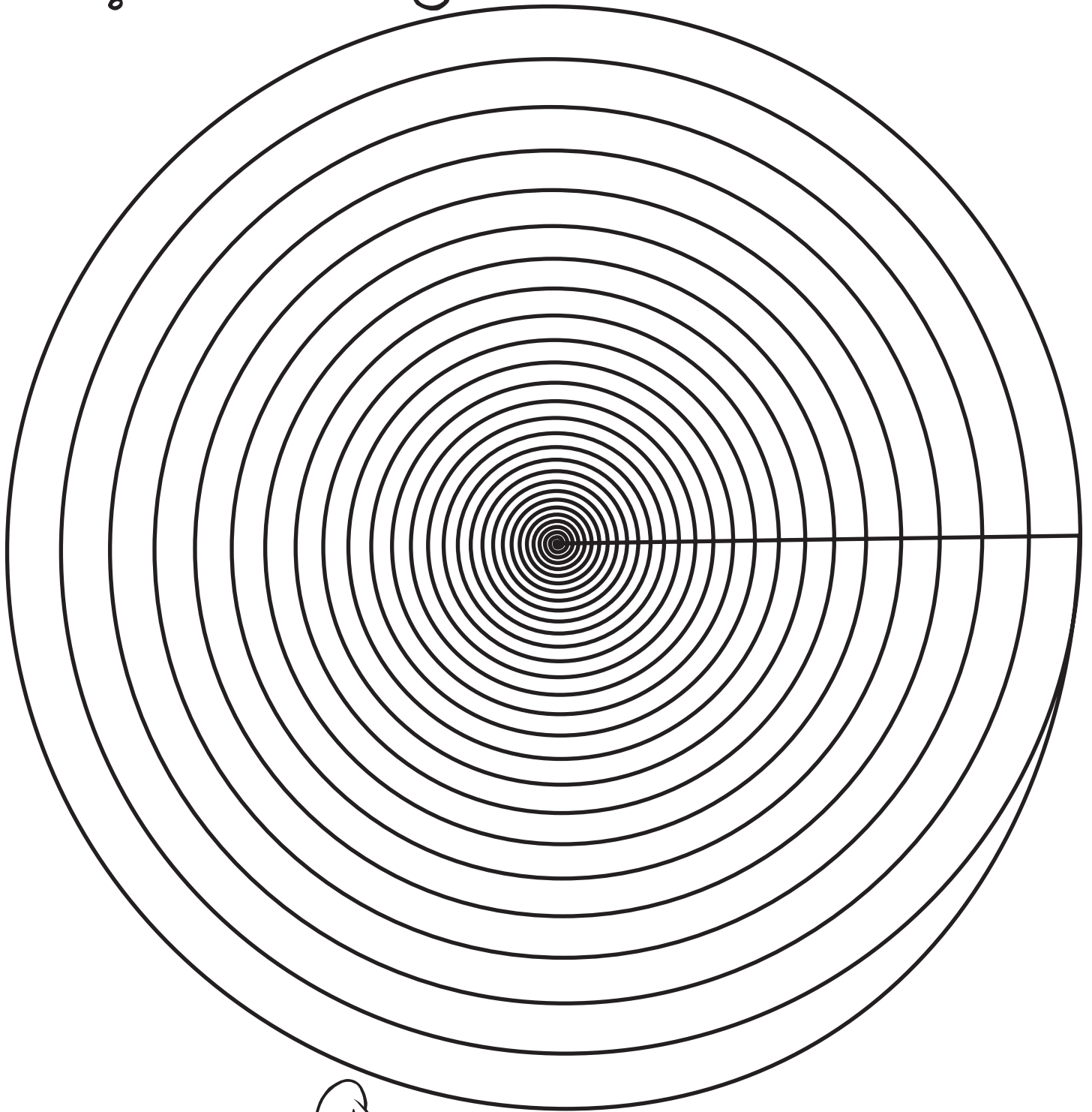

**Colour this spiral pattern,
but don't cross over any lines.
Things may not be what they seem.**

Sudoku - Medium Puzzle 1

6		9			2	7		3
1			6	8				
		2					1	
		4	9				5	
	5	1	4				7	
		8		7		3	2	
8			3			2		
4	2					9		
		3		6	5	1		8

Sudoku - Medium Puzzle 2

			4	2			5	
		6		3	1			4
3	2					1	9	
			5			8		
8		5					6	
9		7	1	4		3		
	5				7			
2			3					8
	7	3			2	9	1	6

Sudoku - Medium Puzzle 3

6		1	4	3			2	7
			5			1		
		9	8				5	
3						9		4
9	2	7	6		4	3		
	8		7				6	
		6	9		5		3	
		2		1			4	
4								8



Sudoku - Medium Puzzle 4

	2				3	1	8	
3	9		2				6	5
				6	1			7
		9	8		4	7		
1				3		8		
		5	6			9		
4	5				8			
			7	2			4	
		3			6	5		2

Sudoku - Medium Puzzle 5

1			8		3			
		2					6	1
8			6		7	2		3
							6	3
	6			4				7
3	5		7	6	9			
		7	4					5
		9					3	4
	2			8	5		1	

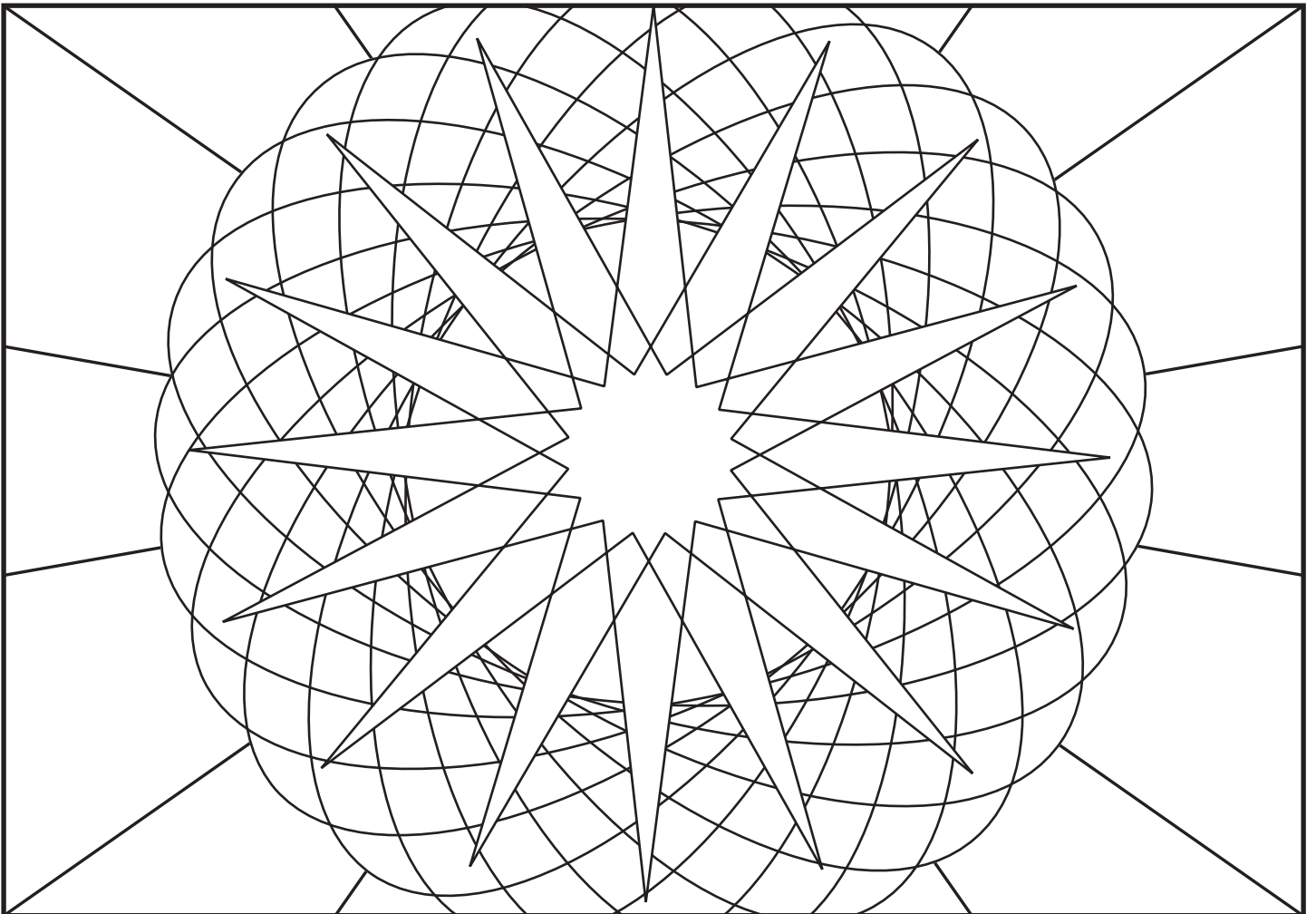
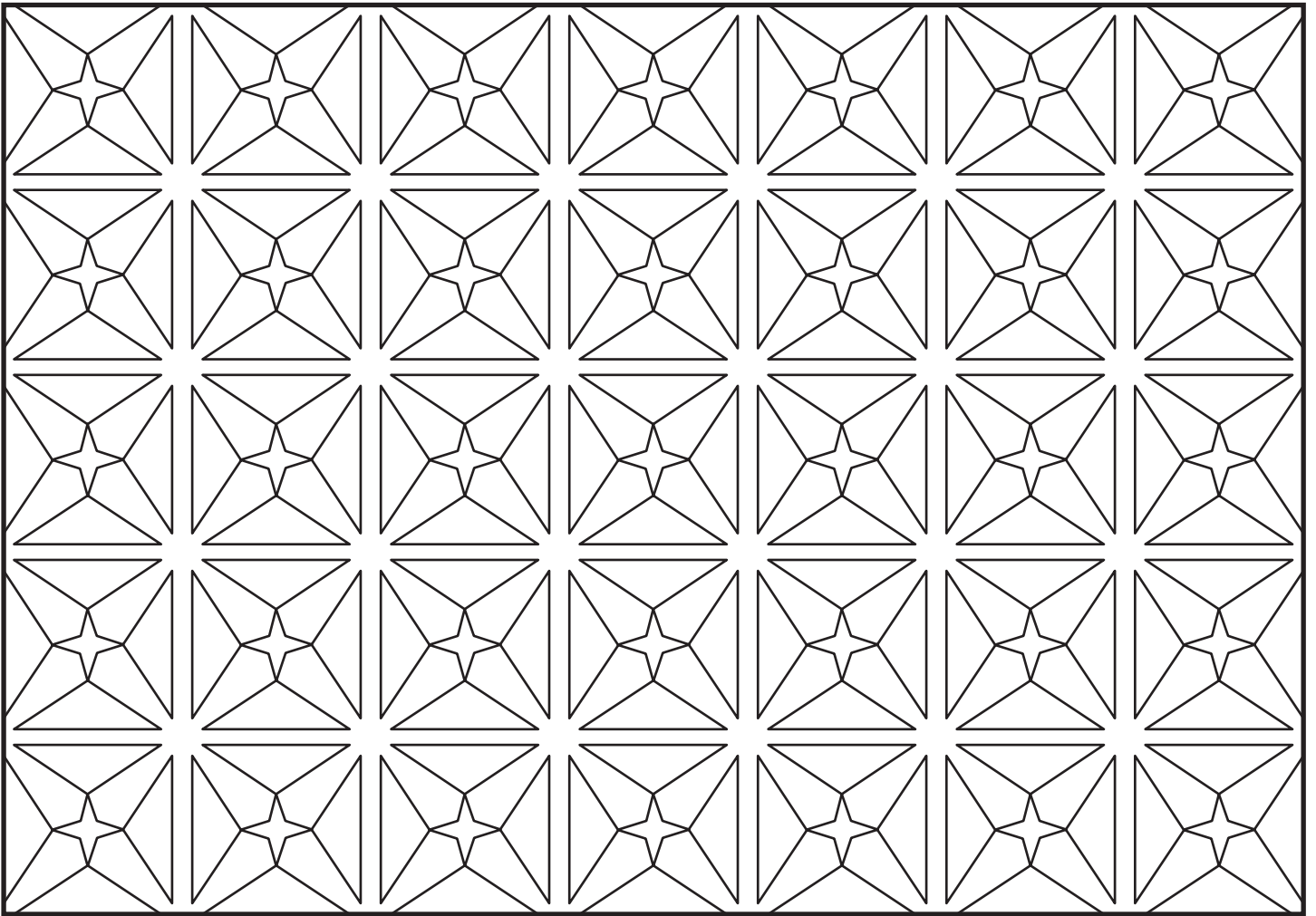

Email

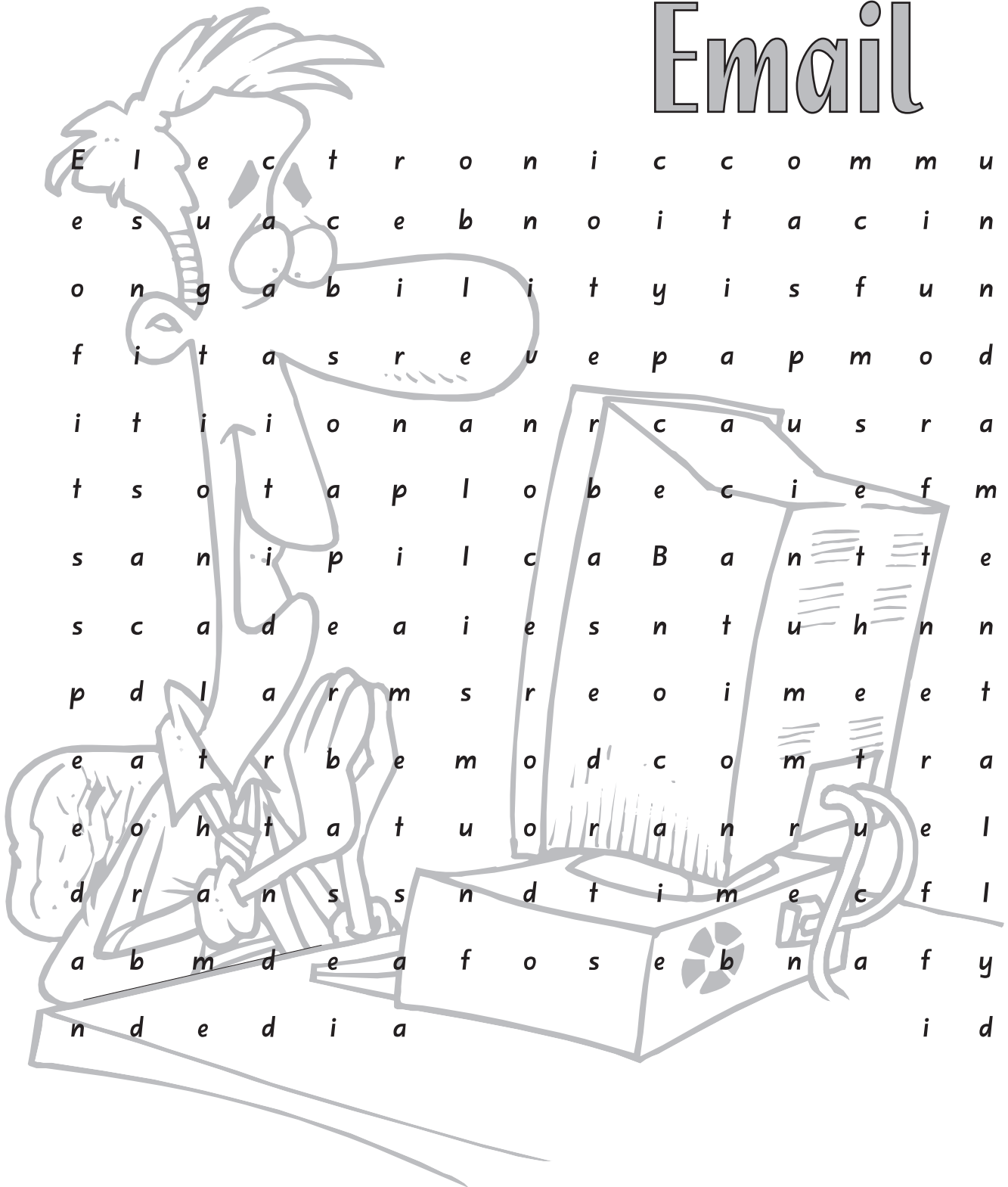

E l e c t r o n i c c o m m u
e s u a c e b n o i t a c i n
o n g a b i l i t y i s f u n
f i t a s r e u e p a p m o d
i t i i o n a n r c a u s r a
t s o t a p l o b e c i e f m
s a n i p i l c a B a n t t e
s c a d e a i e s n t u h n n
p d l a r m s r e o i m e e t
e a t r b e m o d c o m t r a
e o h t a t u o r a n r u e l
d r a n s s n d t i m e c f l
a b m d e a f o s e b n a f y
n d e d i a i d

Starting at the top left-hand corner, draw a line as you follow these sentences about email.
Don't cross over any lines.

Electronic communication, because of its speed and broadcasting ability, is fundamentally different from paper-based communication. Because the turnaround time can be so fast, email is more conversational than traditional paper-based media.

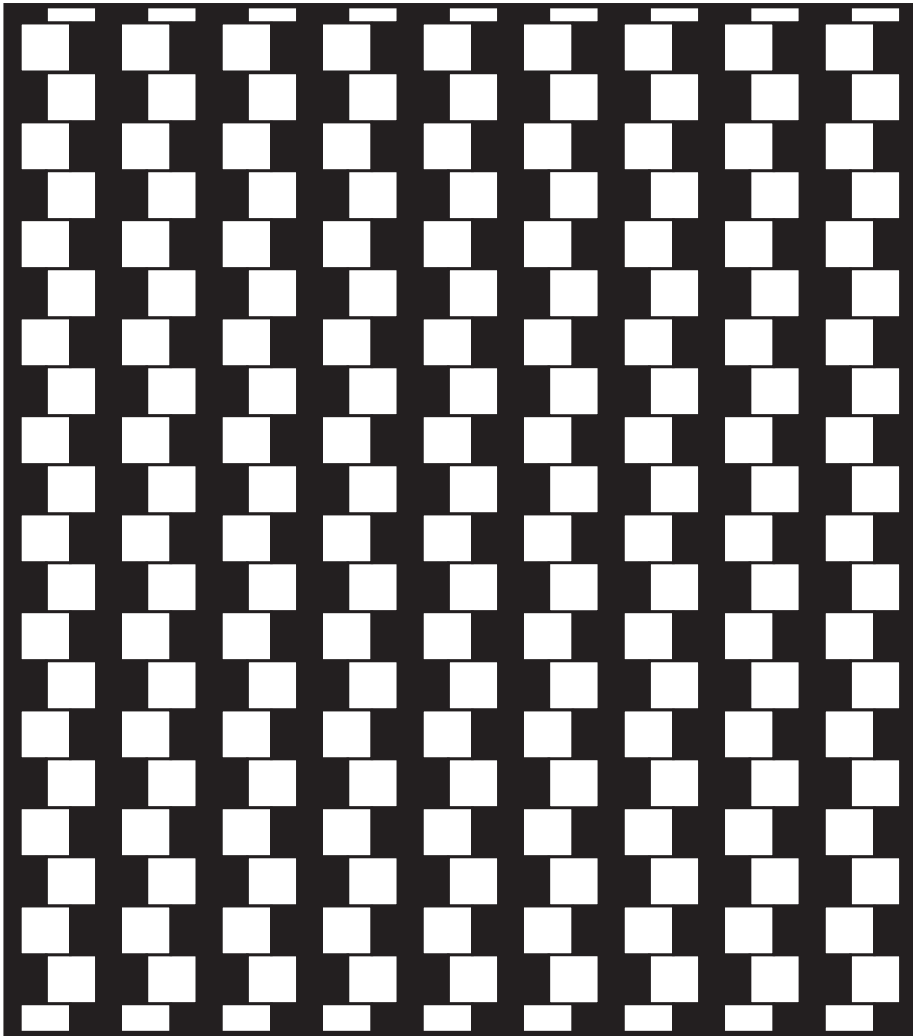

KEEP THIS QUIET!

- ☆ These rows of black and white tiles are perfectly even.
- ☆ Place a ruler along the rows to prove it.
- ☆ Add colour to the white tiles to see if it changes the illusion.

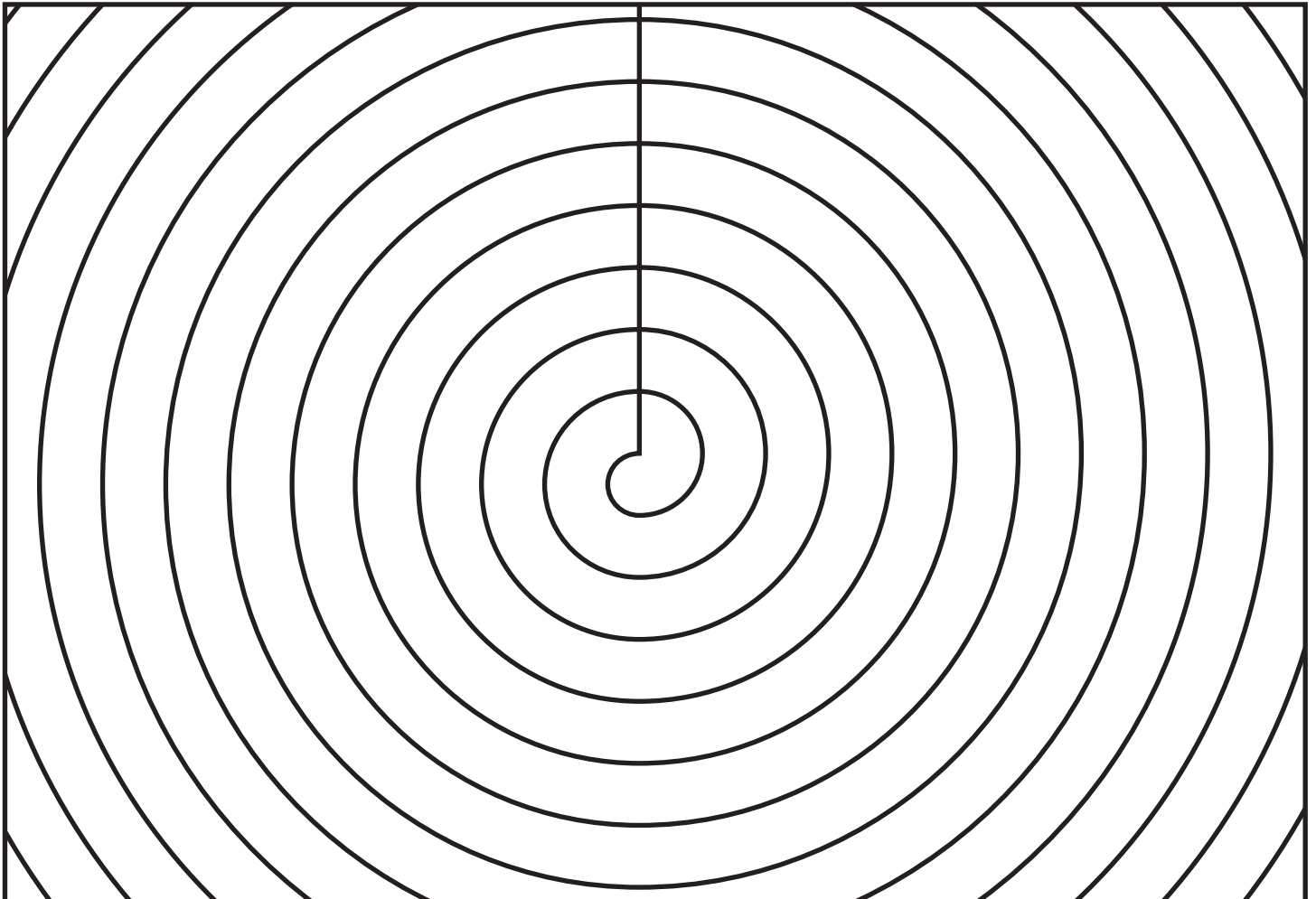

DR SCHWEITZER

Start at the top left corner. Moving right, left, up or down, try to make sense of it.
Drawing a line as you might help, as no letters are used twice.

D	r	S	c	h			m	a	l	l	n	o	n	h	a	n	l	i	f
				w	e	i	s	d						u	m	e	b	A	e
						t	z	e	r	a	p	s				e	t	t	h
			e	l	e	r	e	r	a	l	w	s					h	a	a
d	e	s	a		d					a	y		n	w	o	l	f	d	
H		d	s	t	a	n						n	i						
e	w	l	p	e	t	i			n	r	e	d	d	o		u	l	d	
	o	u	a	s	i	h	t	a	e			n	u	o	r	o	e	b	
				d						c	a	d	r	s	w	c			
	l	t			e	r				m	e	r	o	a		a			
a	e	e	e	b		a	t	h	s	o		d	b			p	t	u	
w				a	t	t	r	e	s	s	a	l	g	g	n			r	
o	r	m			n	h								i			e		
					a	a								k		d	a	d	
			h	a	n	n								n	i	r	y	b	
			s	u	r	c													

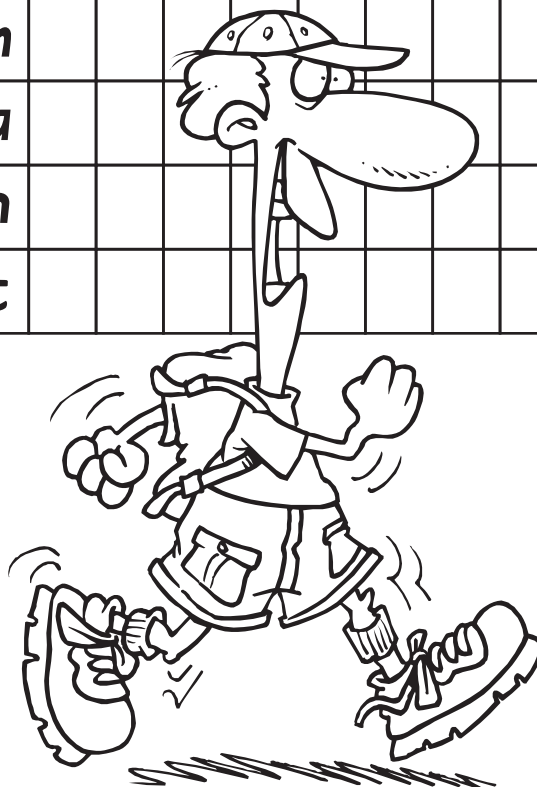

-OUTWORDS

C	W	R	T	O	U	T	R	A	T	E	G	A	R	T	U	O	U	T	S	P	E	D	R	L
A	X	K	F	Q	W	E	L	F	T	U	O	R	O	O	O	J	W	T	Y	P	H	L	A	N
G	O	V	C	O	B	O	P	M	U	J	T	U	O	U	U	Z	O	K	A	N	O	D	E	E
O	U	P	A	L	O	U	T	S	E	L	L	T	T	T	T	A	U	L	U	H	D	H	C	
U	T	G	U	S	B	S	T	T	U	A	M	B	F	D	D	G	F	O	T	A	P	Q	T	A
T	D	L	U	A	H	T	U	O	E	O	R	Y	O	A	R	R	U	L	U	R	T	D	U	R
R	O	C	N	O	S	C	U	A	M	A	U	U	I	T	A	E	A	N	O	T	O	T	O	T
A	O	E	C	A	R	A	W	O	G	Q	T	T	Q	E	G	N	W	W	S	W	V	D	U	U
N	R	U	C	I	G	T	O	Q	M	D	T	S	I	N	D	Q	O	O	T	S	U	O	E	O
K	O	T	T	I	E	U	P	C	O	O	V	O	Y	N	X	M	U	U	U	U	E	T	Q	
O	U	U	B	T	O	E	N	H	H	U	M	Y	D	G	I	T	I	T	T	O	P	Y	E	
O	O	U	T	L	I	V	E	S	N	U	R	T	U	O	S	S	W	X	F	W	C	V	L	R
L	O	E	A	L	T	D	T	M	V	J	S	U	H	W	Z	B	I	I	G	N	O	R	P	G
T	U	S	O	H	A	U	S	O	O	Y	O	O	A	U	O	U	T	L	I	N	E	R	O	K
U	T	Y	U	U	O	I	U	X	U	C	U	L	P	T	N	S	S	V	K	B	Z	U	N	P
O	D	V	T	W	T	T	D	B	T	T	T	E	D	I	S	T	U	O	U	T	T	A	K	E
U	R	O	P	I	W	W	T	V	C	U	K	U	O	O	O	U	T	S	O	L	D	N	R	C
T	A	U	L	E	P	U	A	O	O	W	E	I	O	U	U	A	P	E	E	K	T	U	O	A
R	W	T	A	F	O	T	U	L	O	B	P	L	L	T	T	O	U	T	S	W	A	M	T	F
O	G	R	Y	O	I	T	U	R	K	U	T	D	L	L	P	D	S	T	I	S	T	U	O	T
A	F	U	Q	Q	P	C	G	O	X	C	T	V	A	E	O	C	O	U	T	L	I	E	S	U
R	K	S	A	O	U	T	S	W	I	M	U	S	F	A	U	G	C	E	C	A	P	T	U	O
U	M	H	S	O	U	T	P	U	T	S	N	Q	T	P	R	O	U	T	S	A	N	G	L	S
E	S	T	L	O	U	T	Y	E	L	L	I	R	U	A	O	U	T	G	A	I	N	M	M	J
H	S	I	F	T	U	O	W	E	R	G	T	U	O	P	Y	O	U	T	R	I	D	E	U	N

- OUTCROP
- OUTLINE
- OUTWITS
- OUTWEAR
- OUTWORN
- OUTRUNS
- OUTTRACE
- OUTPLAY
- OUTLETS
- OUTGREW
- OUTSWAM
- OUTSIDE
- OUTLIES
- OUTRAGE
- OUTROAR
- OUTPACE
- OUTRUSH
- OUTSHOT
- OUTSWIM
- OUTSANG

- OUTGUNS
- OUTJUMP
- OUTBUYS
- OUTDATE
- OUTFLOW
- OUTGROW
- OUTINGS
- OUTHUNT
- OUTKILL
- OUTLEAP
- OUTDOES
- OUTLAYS
- OUTSPED
- OUTRODE
- OUTTALK
- OUTVOTE
- OUTFALL
- OUTFITS
- OUTDRAW
- OUTDRAG



- OUTLAST
- OUTLIVE
- OUTBIDS
- OUTCOME
- OUTDONE
- OUTEATS
- OUTACTS
- OUTCAST
- OUTLAWS
- OUTLOOK
- OUTBACK
- OUTSELL
- OUTLAID
- OUTMOST
- OUTBRAG
- OUTCOOK
- OUTDOOR
- OUTDREW
- OUTFLEW
- OUTHAUL

- OUTRANK
- OUTPITY
- OUTPOUR
- OUTSTAY
- OUTRATE
- OUTWALK
- OUTFACE
- OUTPUTS
- OUTYELL
- OUTWARD
- OUTSOLD
- OUTLAND
- OUTKEEP
- OUTTAKE
- OUTHEAR
- OUTPOST
- OUTSITS
- OUTGAIN
- OUTKEPT
- OUTFISH
- OUTRIDE

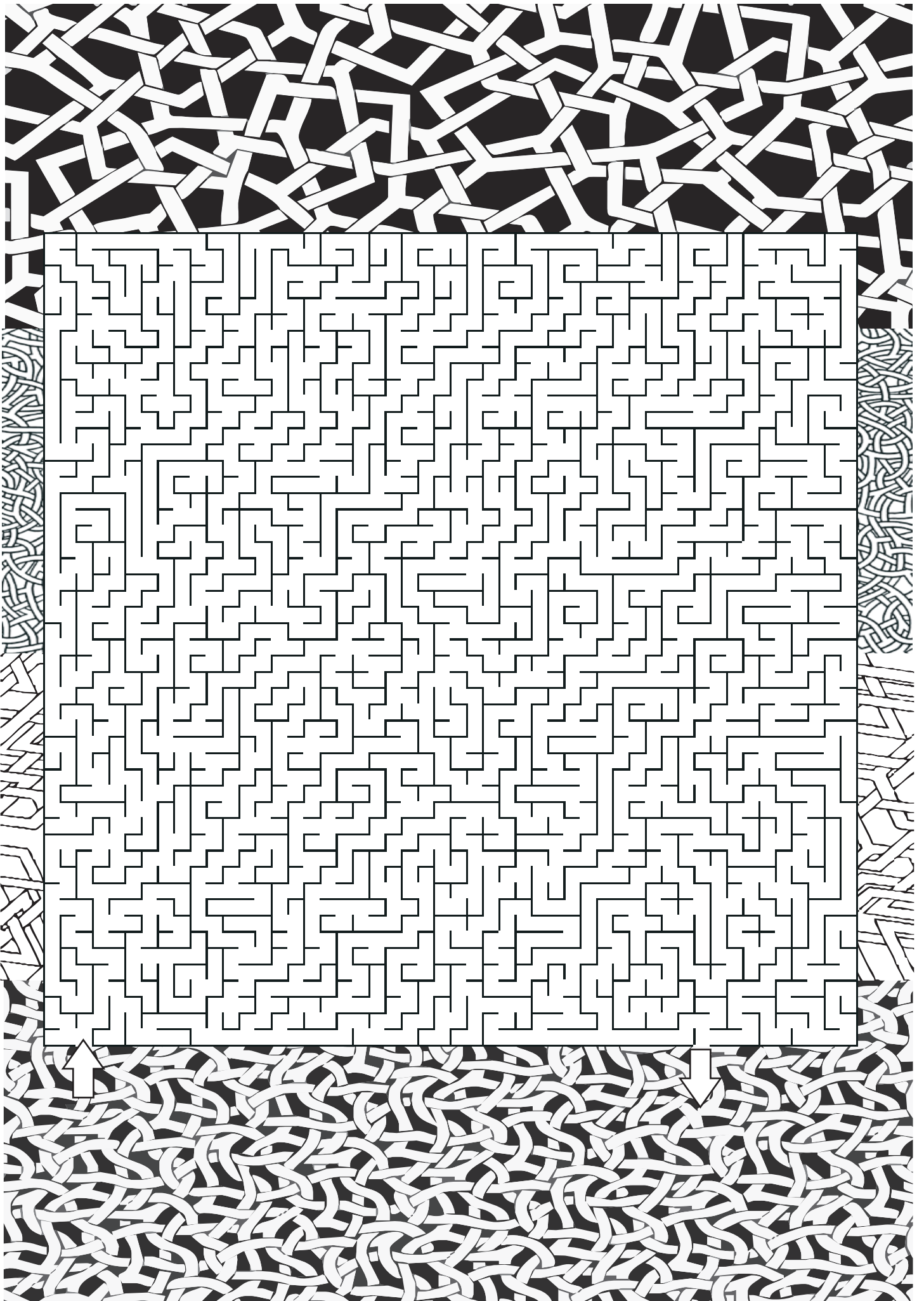

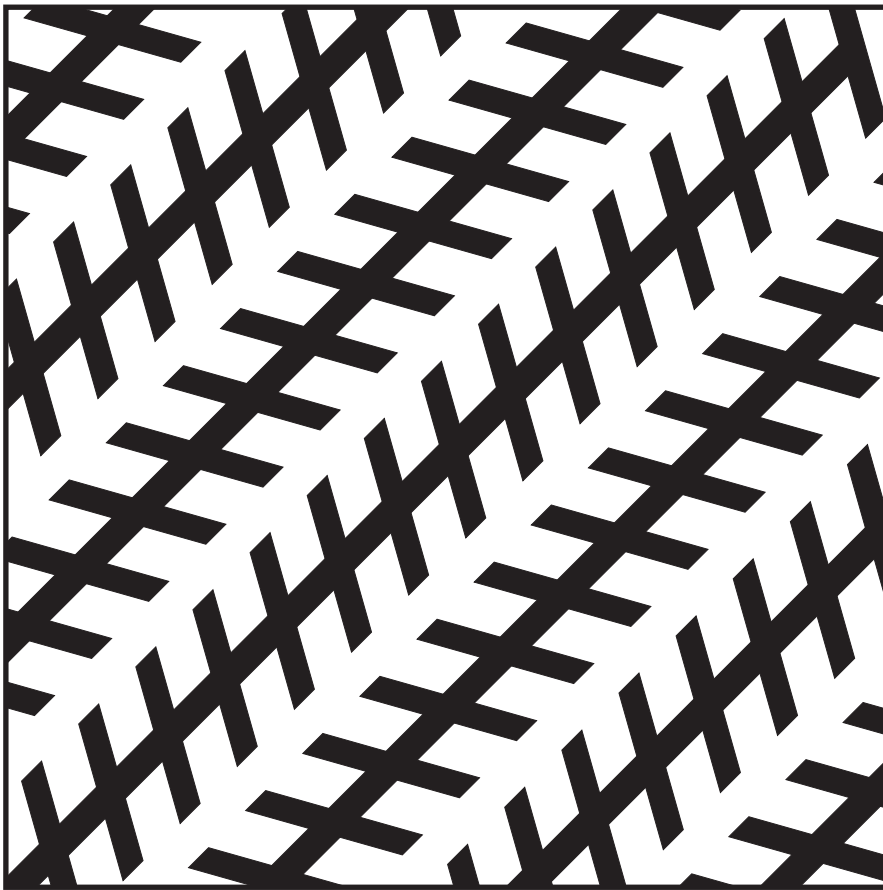

Check to make sure that the long slanting lines are parallel before colouring in this pattern

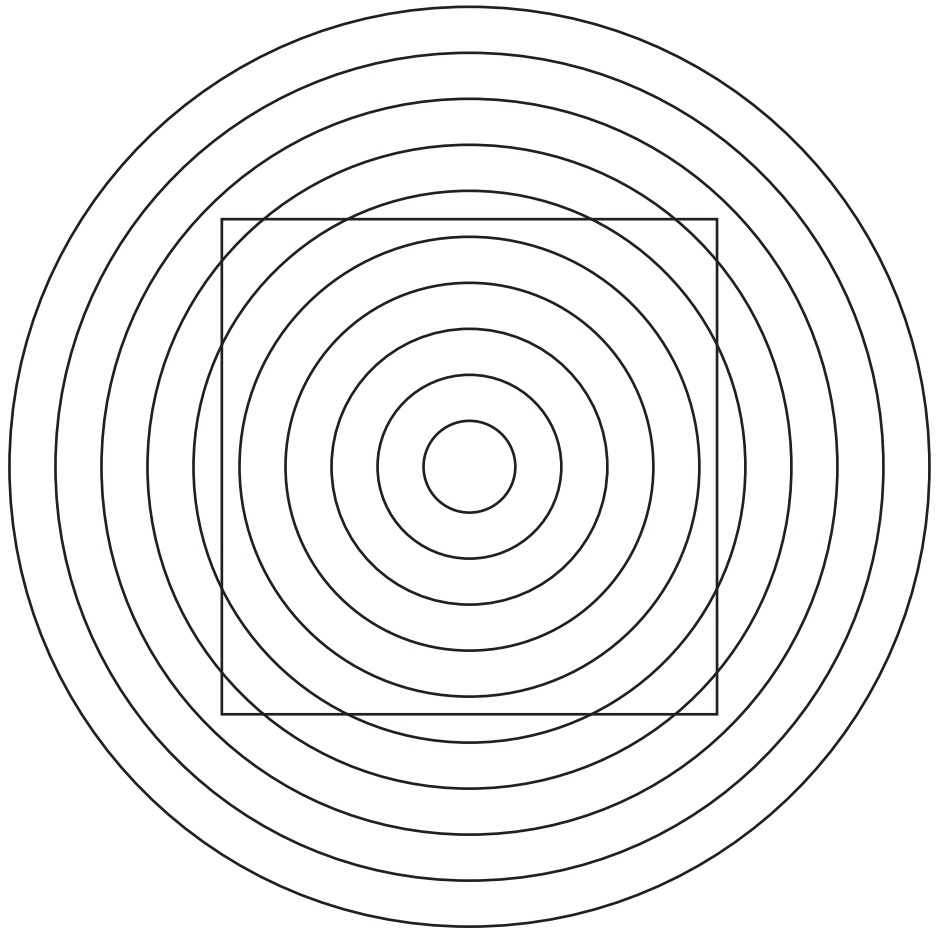
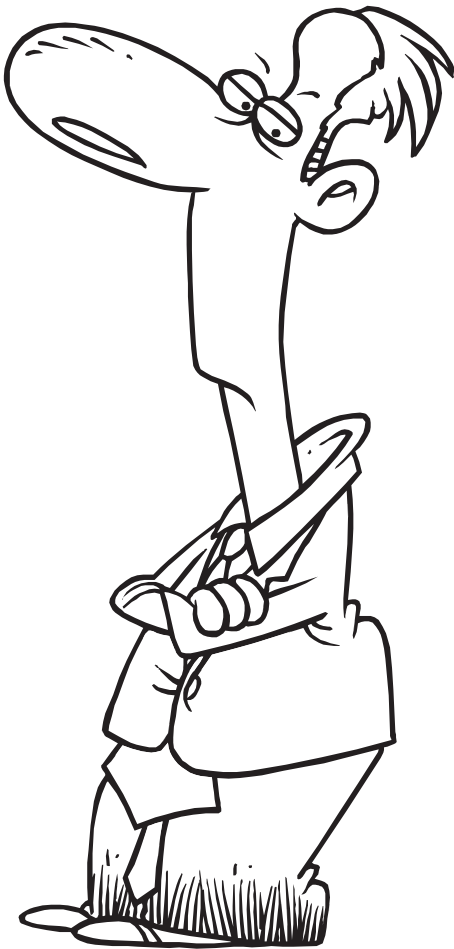

The sides of the square appear to be bent.
In fact they are perfectly straight.
Use colour to highlight this symmetrical pattern.



Sudoku - Hard Puzzle 1

			5					3	
		5						4	
	8	4	7	1				6	
	7	8					1		
	3		6	2					
6			8				3	9	
					7			9	
9		7	1					5	2
		2	4						

Sudoku - Hard Puzzle 2

3	2			4		1		6
					5			
9			2			7		
		9					1	
8		4	5	6			2	9
					4			
	3		8					
	7	2		1				5
		8		7		6	3	

Sudoku - Hard Puzzle 3

					6				
4		6		9			8	5	
	2			7			1		
6			8					1	
			3				5		
5	4				2			7	
	5							3	
9		8	7	3				2	4
		1	9						

Sudoku - Hard Puzzle 4

			8	2		5		
7	3					8	6	
		5		1		2		
		4	1				3	
9	6							7
				6	9	4		
		7	4					5
		9			6	3		
	2			8			1	

Sudoku - Hard Puzzle 5

		4	1					2
3	2				8	5		
					6	8		9
6		3			4			
				2		6		4
7					1			3
		9			5			2
		1		7				5
	7		8					9

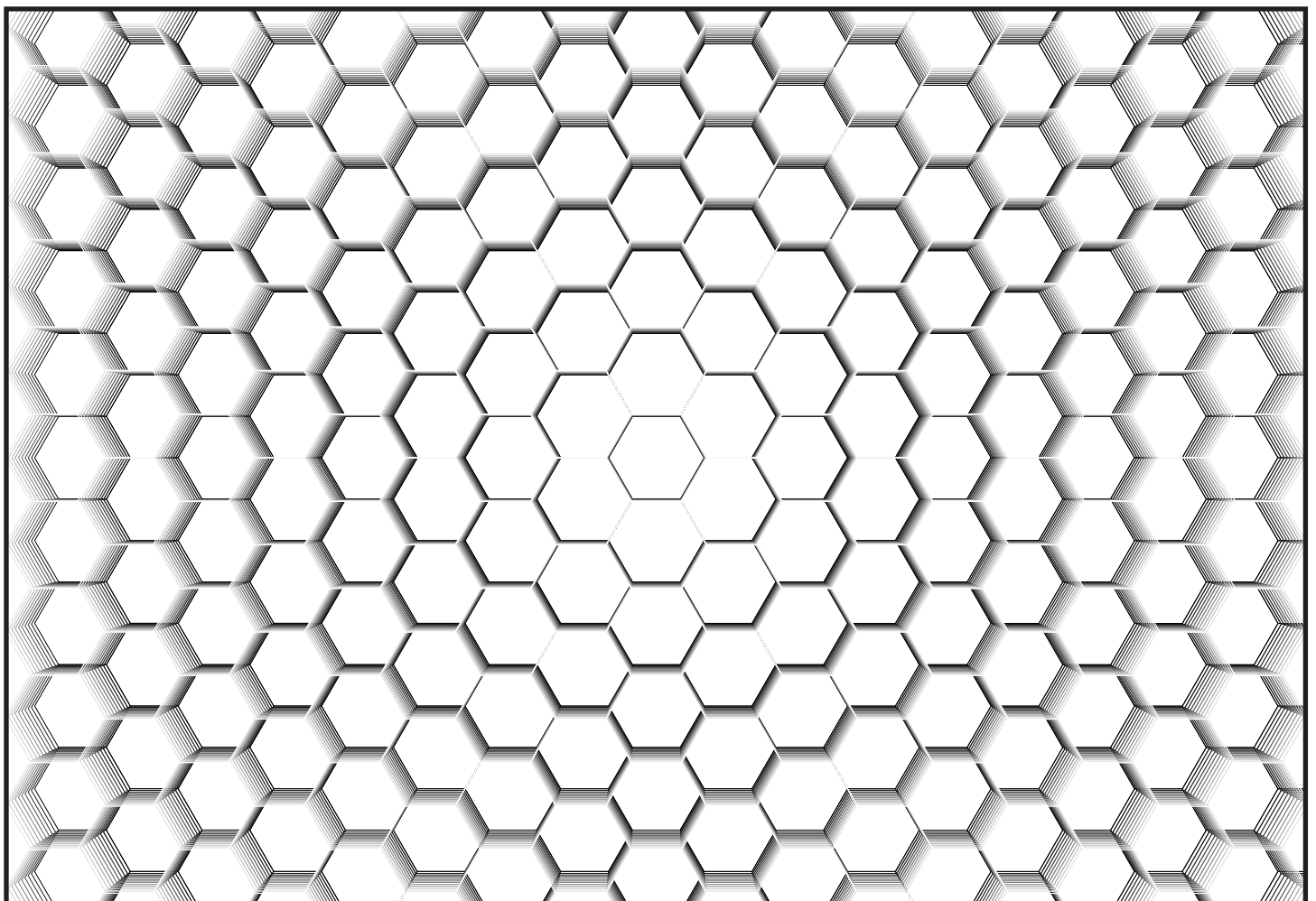
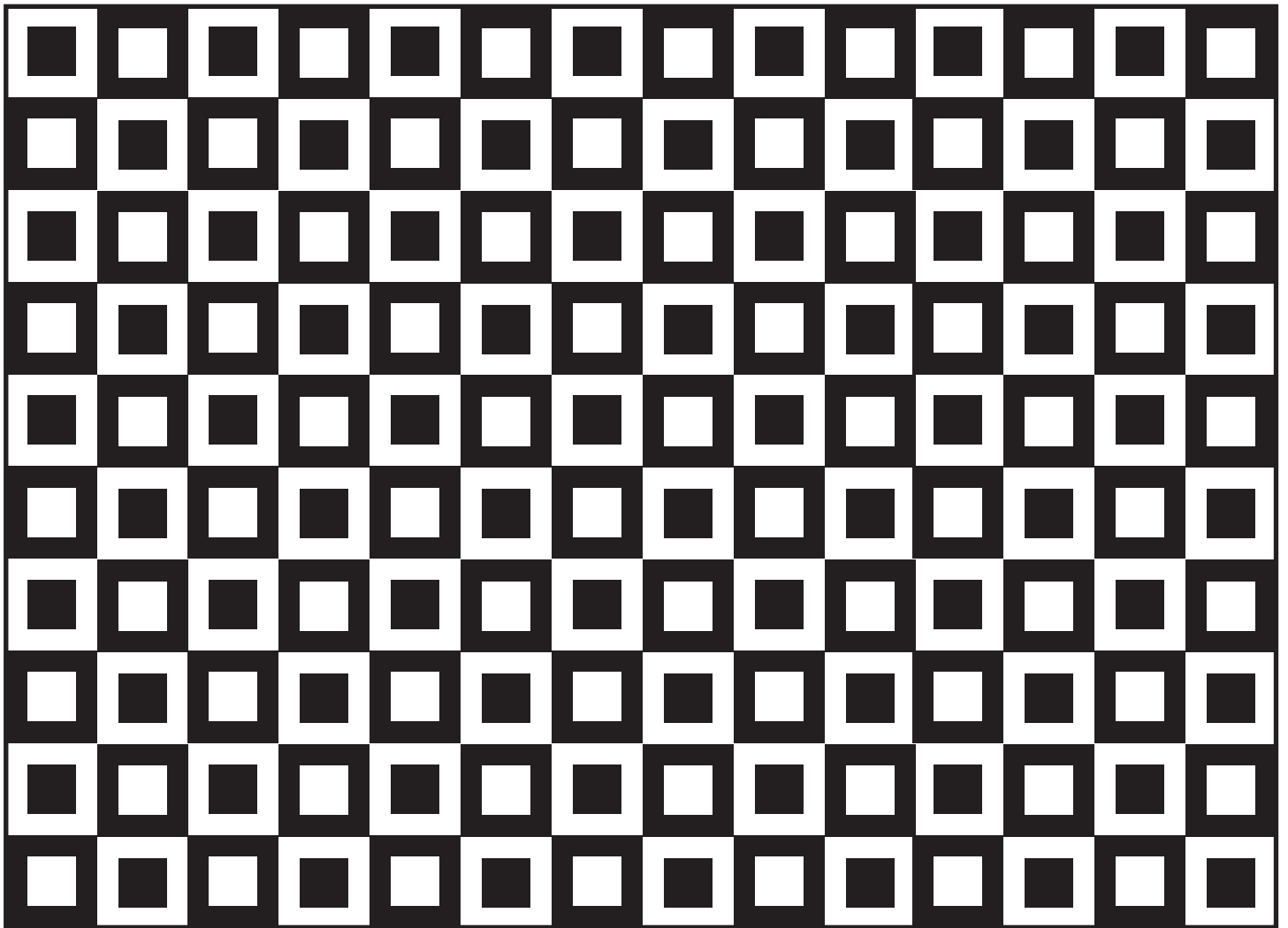

A N I M A L S

H	S	E	L	F	A	C	E	L	L	B	C	G	E	C
C	R	E	A	T	U	R	E	U	S	S	I	T	G	D
E	R	U	B	E	A	S	T	D	B	O	T	P	L	E
G	N	I	V	I	L	T	A	K	E	S	S	W	E	A
A	N	A	M	A	L	E	M	T	I	F	E	O	R	D
N	D	I	E	E	H	P	I	N	N	E	M	R	O	O
A	D	U	V	M	S	I	N	A	G	R	O	L	V	G
M	E	A	L	A	R	V	A	I	N	T	D	D	I	N
C	R	I	T	T	E	R	M	G	Y	I	S	M	N	U
C	A	F	E	M	A	L	E	E	T	L	M	A	M	O
H	E	R	B	I	V	O	R	E	U	I	I	R	O	Y
Y	R	R	A	U	Q	P	S	O	O	Z	W	I	E	O
G	Y	A	E	R	O	V	I	T	C	E	S	N	I	V
O	P	R	E	D	A	T	O	R	S	D	E	E	T	S
E	T	A	R	B	E	T	R	E	V	N	I	A	P	Y

- ANIMATE
- BEAST
- CREATURE
- FAUNA
- FLESH
- TISSUE
- FACE
- HEAD
- ORGANISM
- LIVING
- BEING
- ADULT
- BIPED
- DOG
- CRITTER
- DEAD
- DOMESTIC



- PREDATOR
- INVERTEBRATE
- LEAVING
- MANAGE
- WORLD
- MEAN
- ZOOS
- TAKES
- SWIMS
- STEED
- PAIN
- REARED
- BEAR
- CRAVE
- SCOUT
- CRIME
- CELL



- EMBRYO
- FEMALE
- FERTILIZED
- EGG
- GIANT
- HERBIVORE
- NAME
- INSECTIVORE
- LARVA
- MALE
- MARINE
- OMNIVORE
- PET
- PREY
- QUARRY
- VERMIN
- YOUNG

The left-over letters will spell something that we are all a part of: _ _ _ _ _

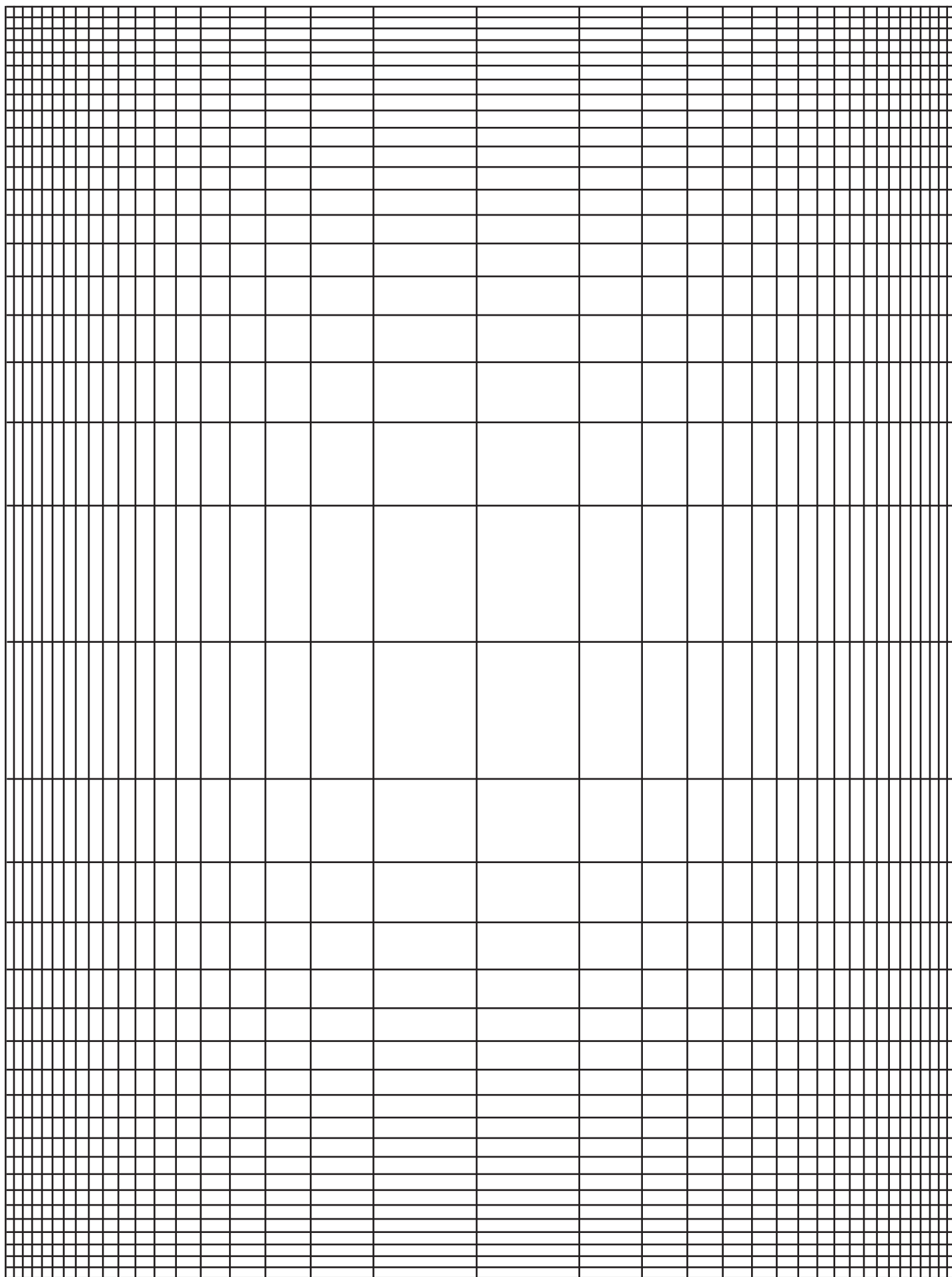

*This pattern is made up of nothing but straight-sided rectangles.
Colour every second rectangle in a checkerboard pattern and
it will get a curved, three-dimensional appearance.*

Are these four planks straight?
Before you colour them, use your ruler
to check how straight they are.

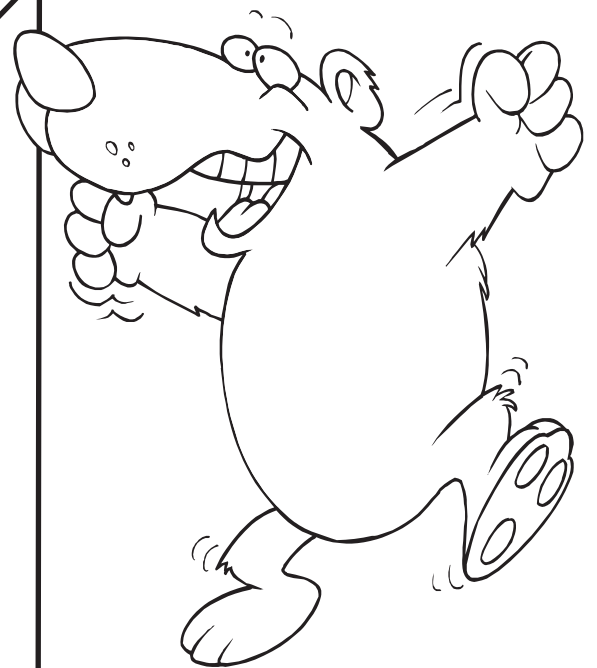
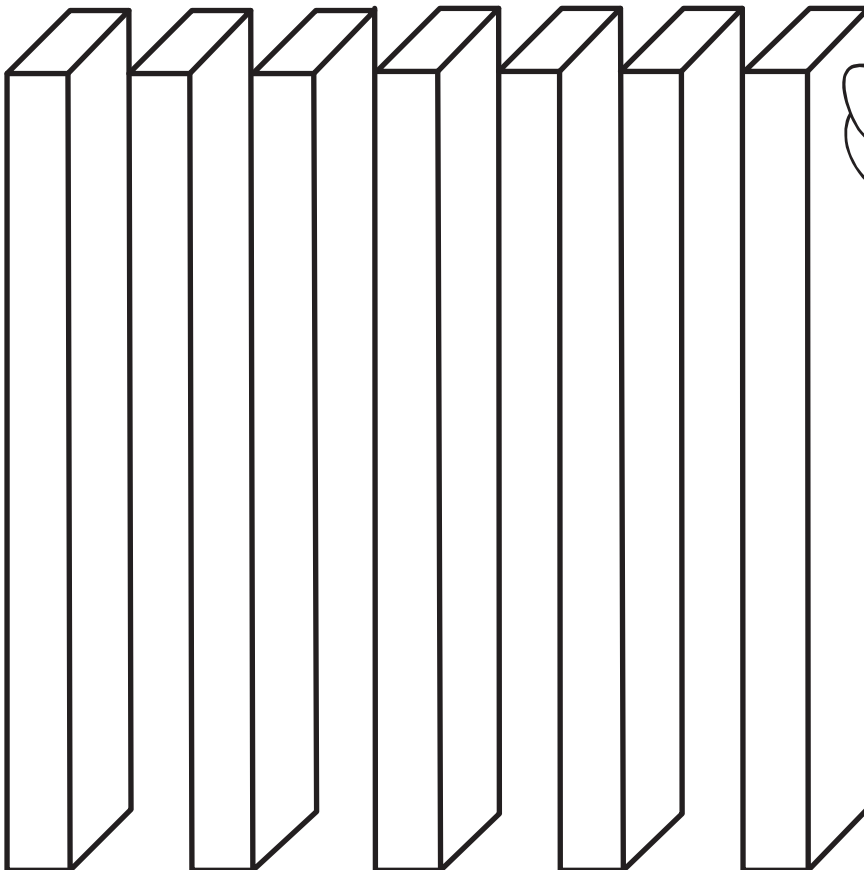
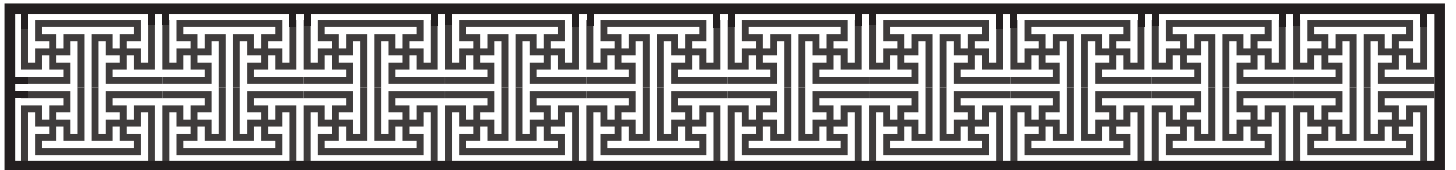
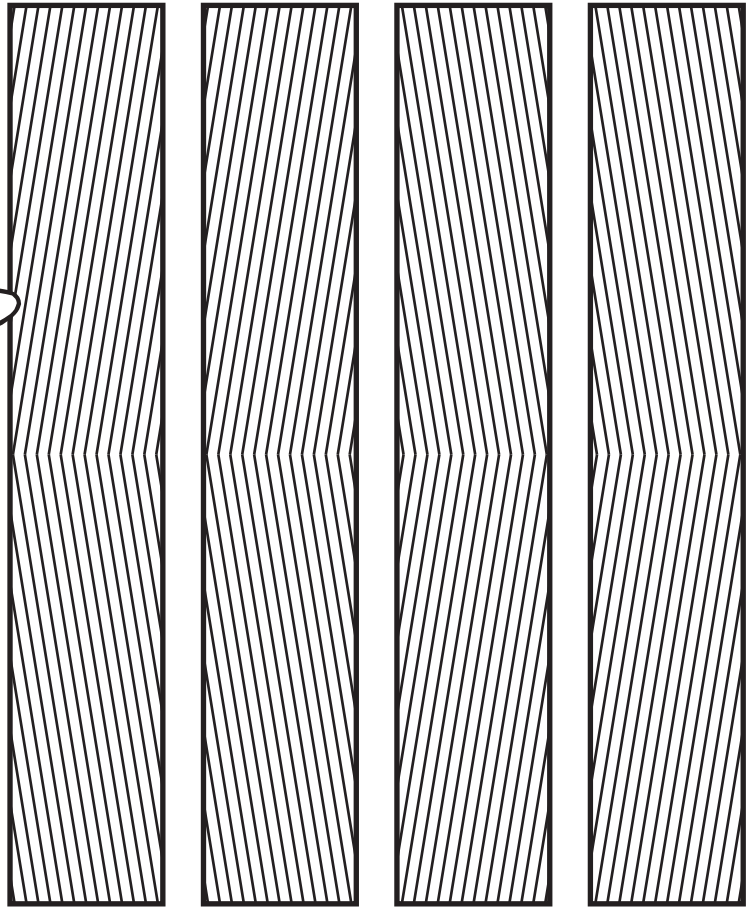

How many planks of wood are there?
Count the number along the bottom
and count the number along the top.
Try to colour the picture.

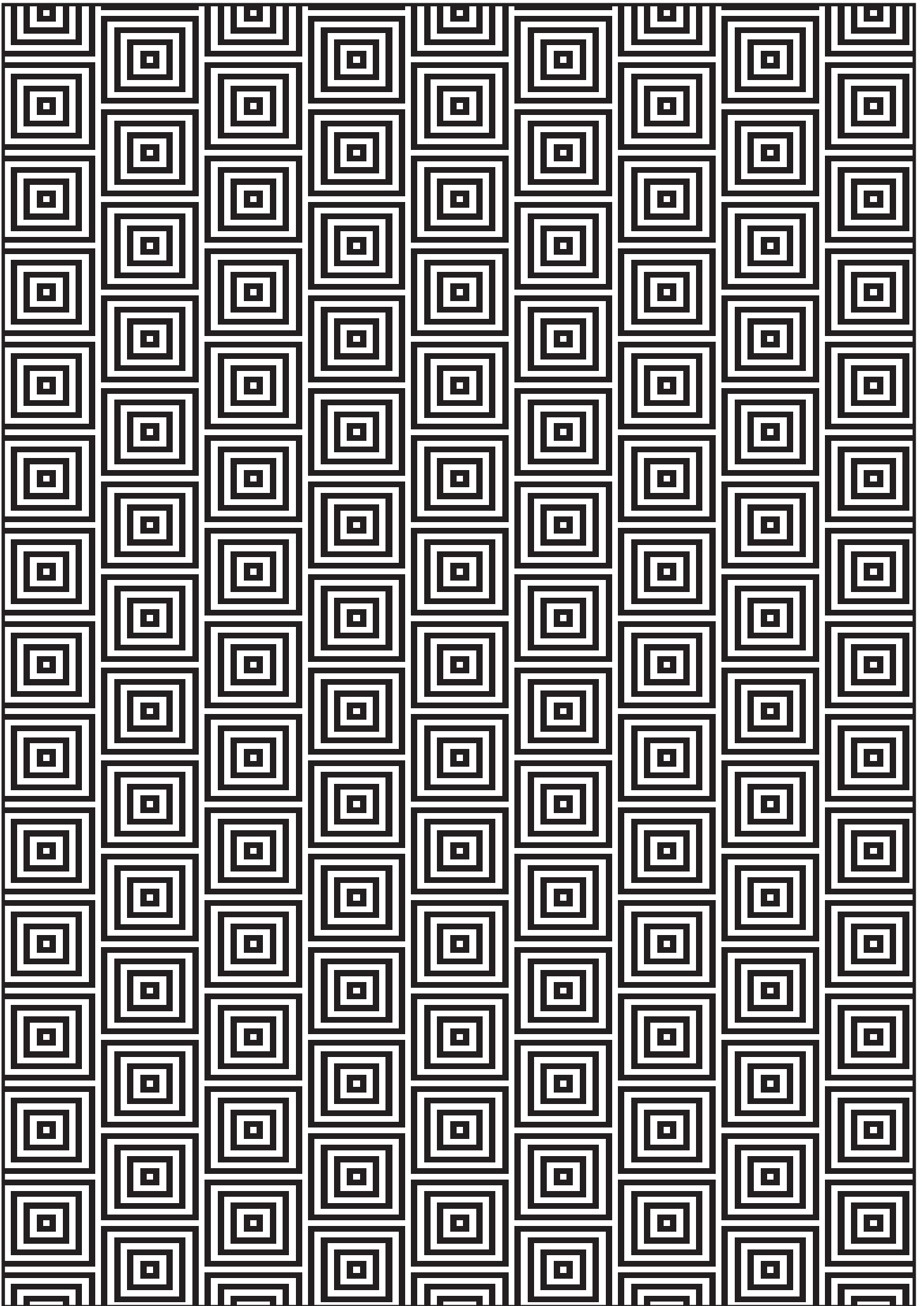

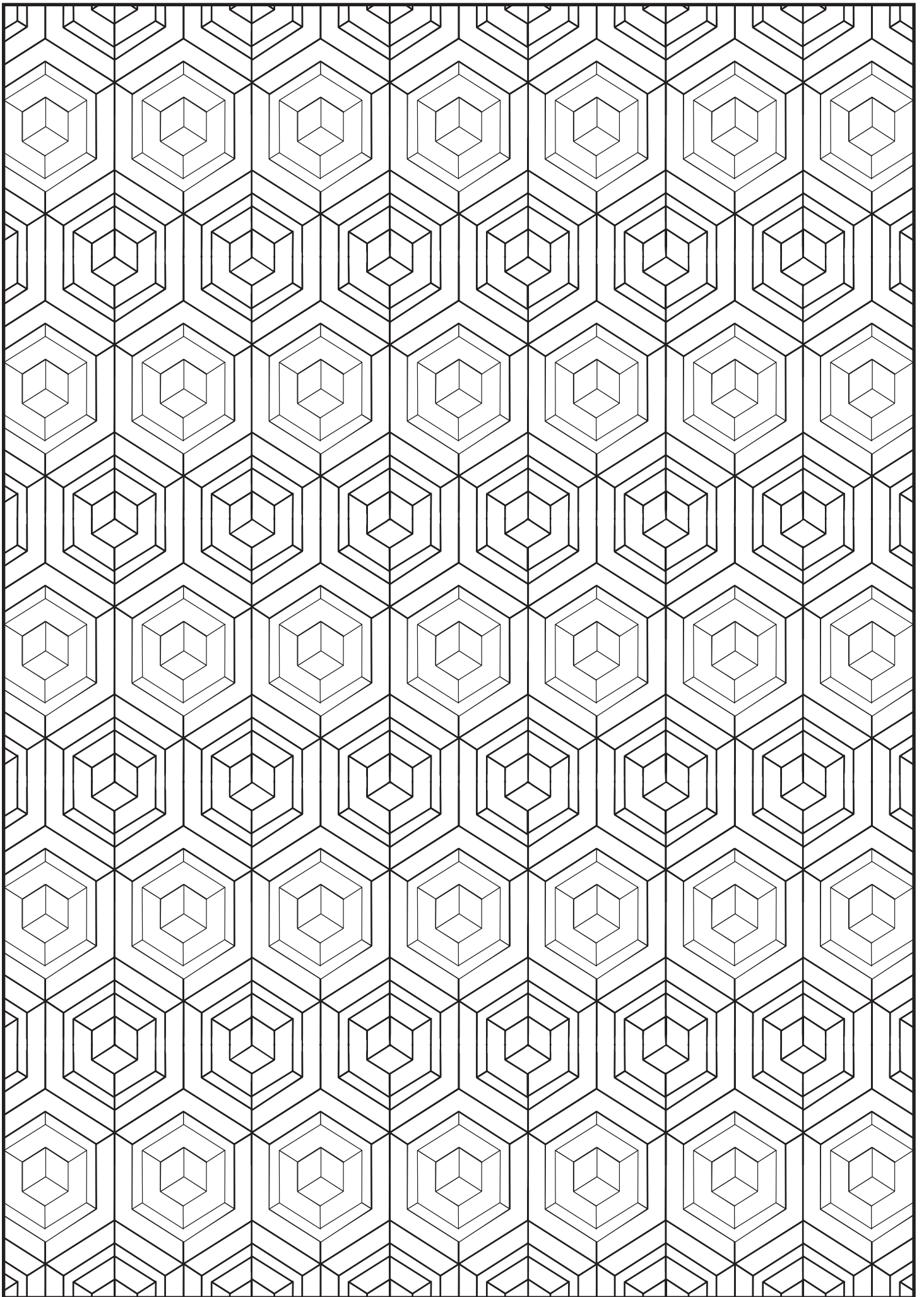

THE HIDDEN SQUARE

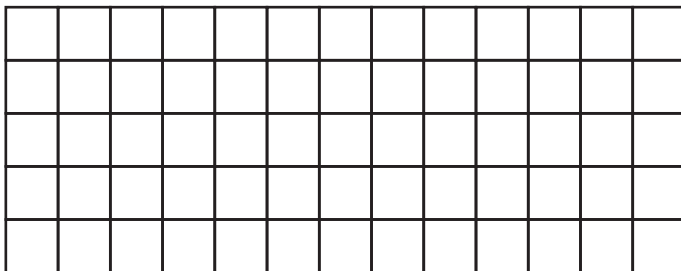
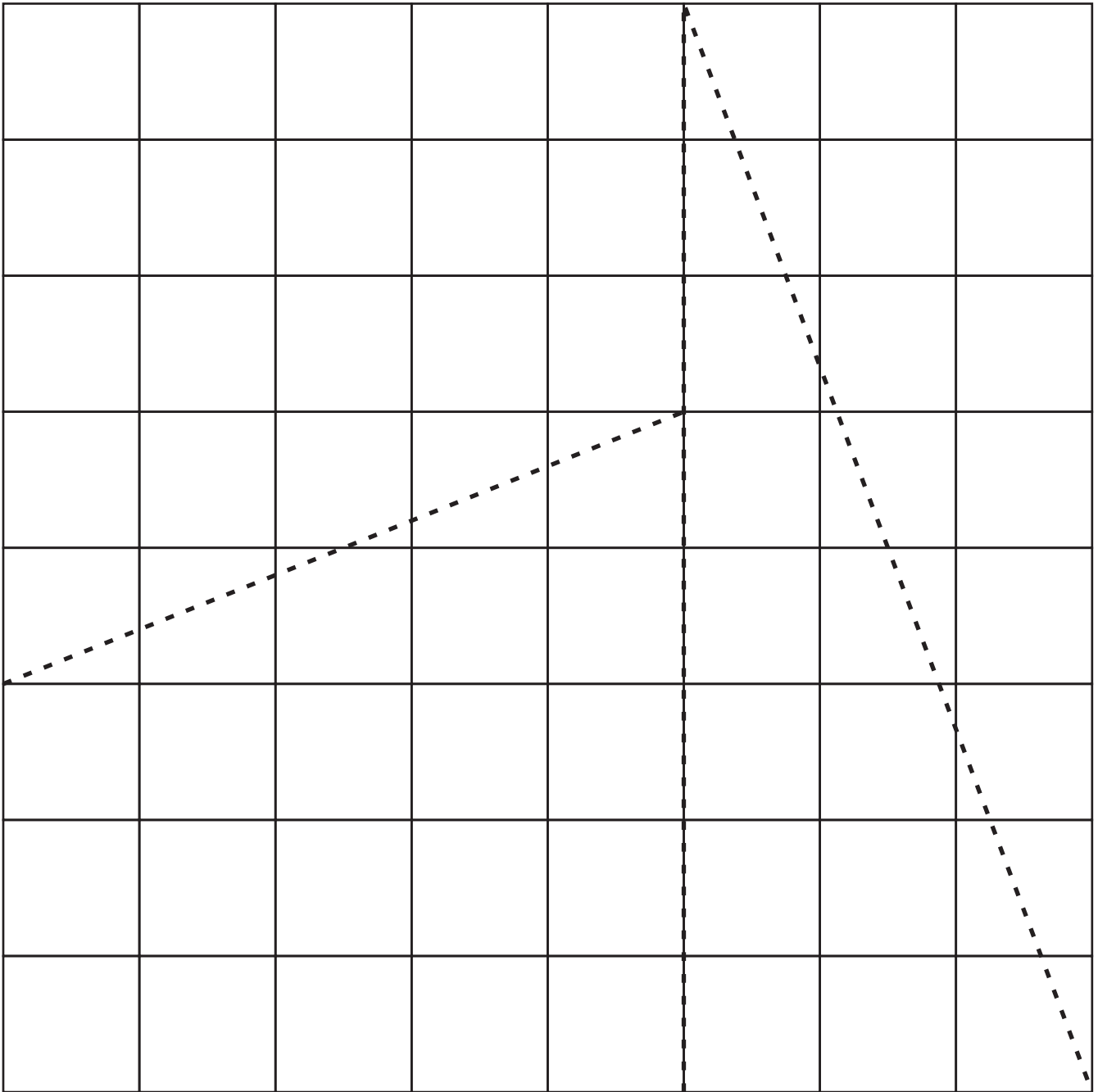

The large square contains 64 smaller squares in a grid of 8 X 8.

If you cut along the dotted lines and reassemble it into the shape shown on the left, it now contains 65 smaller squares in a grid of 13 X 5.

Where did the other square come from?

- PUBLICTRANSPORT
- WHEEL
- VEHICLE
- TUG
- TRUCKING
- TRAMWAY
- ROAD
- RAIL
- TRAILER
- CARAVAN
- SKI
- SHIPPING
- RAFT
- NAVIGATION
- MAPS
- MOVING
- VESSELS
- HORSEBOX
- HAULING
- FREIGHT
- FORWARD
- MAIL
- FLYING
- FLOATING
- FERRY
- SHIPS
- CARGO
- CART
- CHARIOT
- EXPRESS
- CABLE
- BUS
- BARGE
- AERIAL
- SAFETY
- TRAINS
- SHED
- BOATS
- HERE
- TEAMS
- LUNCH
- SPED
- WIPERS
- RATED
- BOLT
- MEET
- PATH
- SALE



PUBLIC
TRANSPORT

V	E	S	S	E	L	S	S	E	R	P	X	E	X	A
F	F	R	F	M	H	A	U	L	I	N	G	E	O	E
L	M	R	C	O	O	M	E	L	B	A	C	G	B	R
O	B	A	E	V	R	C	A	R	A	V	A	N	E	I
A	R	A	G	I	S	W	E	P	S	I	R	I	S	A
T	V	S	R	N	G	L	A	R	S	G	G	Y	R	L
I	F	M	I	G	I	H	E	R	E	A	O	L	O	U
N	T	A	D	A	E	P	T	A	D	T	S	F	H	N
G	R	E	R	A	I	L	P	S	H	I	P	S	S	C
T	H	T	E	W	O	L	A	I	I	O	E	F	A	H
S	Y	A	W	M	A	R	T	S	H	N	D	E	F	A
M	V	E	H	I	C	L	E	K	S	S	B	R	E	R
R	A	T	E	D	O	G	N	I	K	C	U	R	T	I
T	A	I	E	B	S	U	B	O	A	T	S	Y	Y	O
P	U	B	L	I	C	T	R	A	N	S	P	O	R	T

The left-over letters will spell a bunch of these:
(Very handy if you are moving).

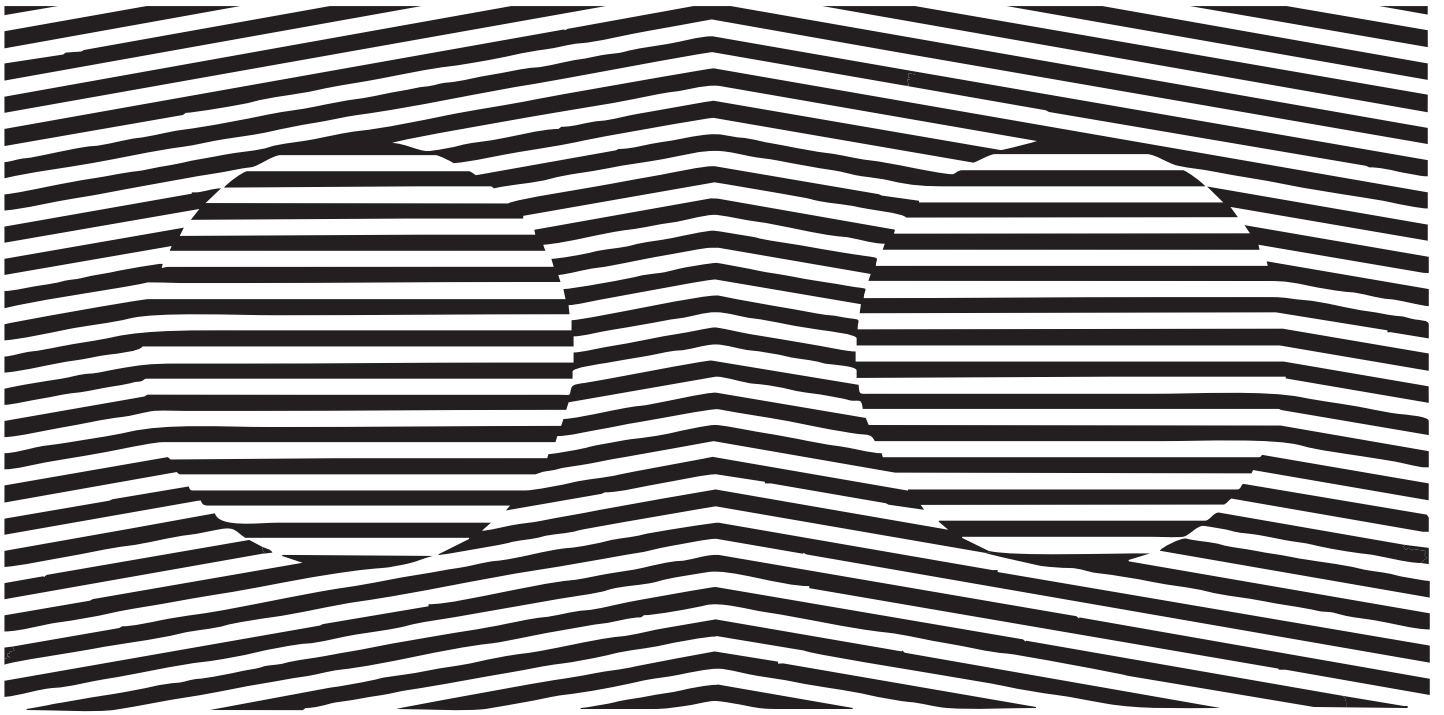

The stripes in both circles are exactly horizontal, although they appear to slope towards the centre. Finish this pattern with bright colours.

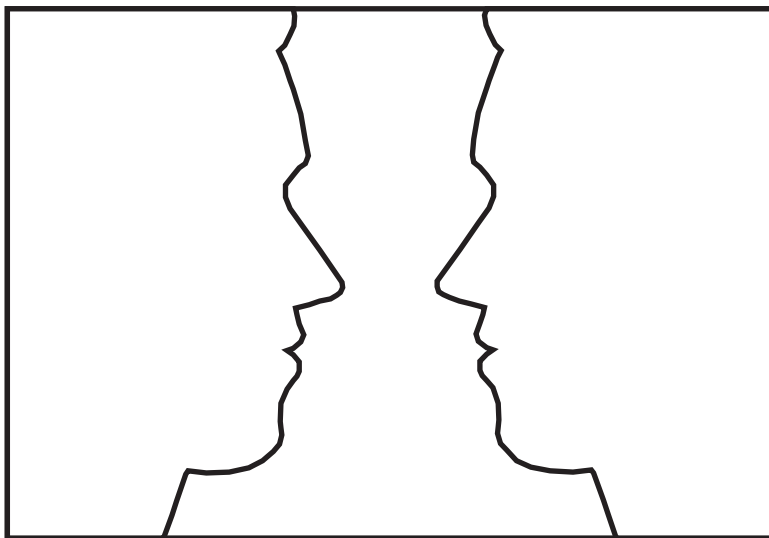

Colour the faces.

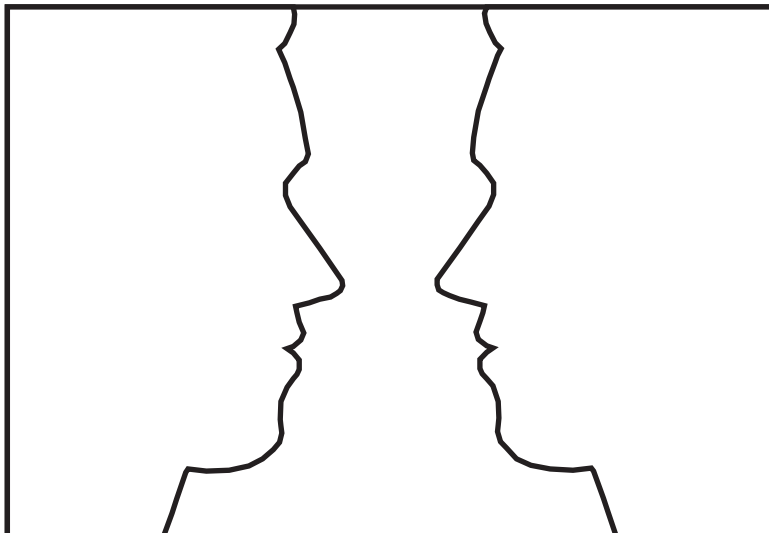

Colour the vase.

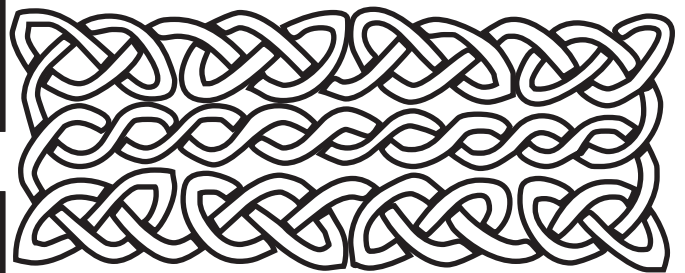

Explore these interesting designs with some colour.

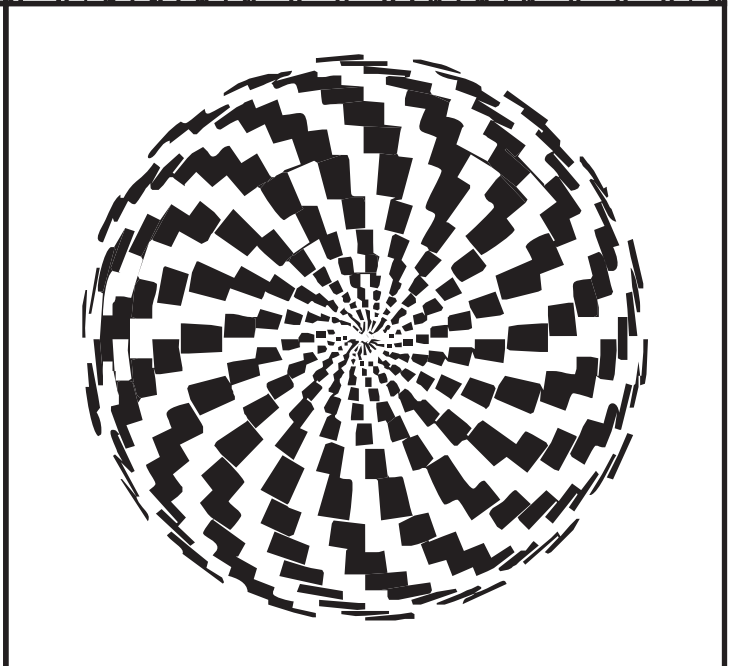
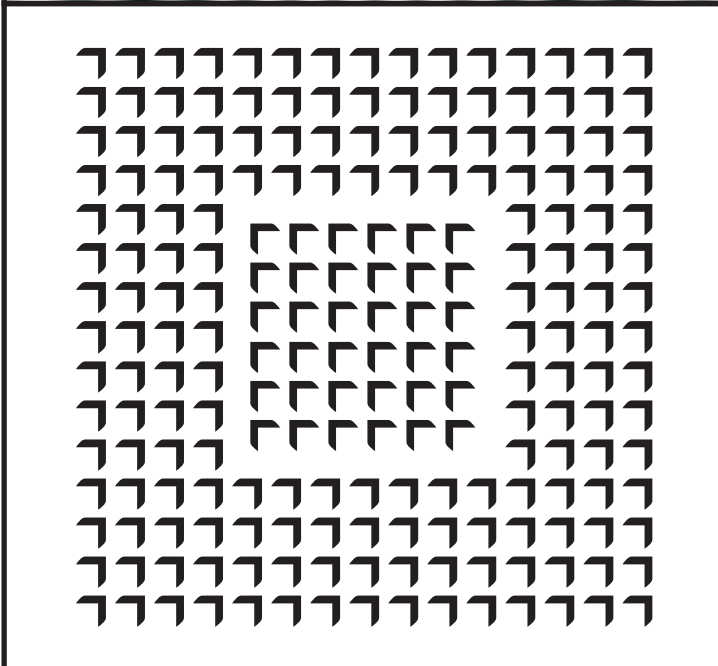
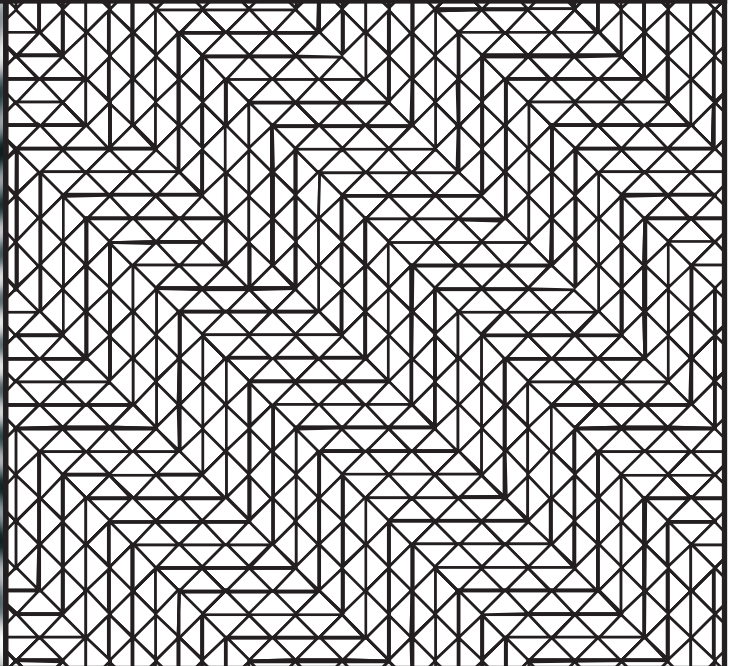
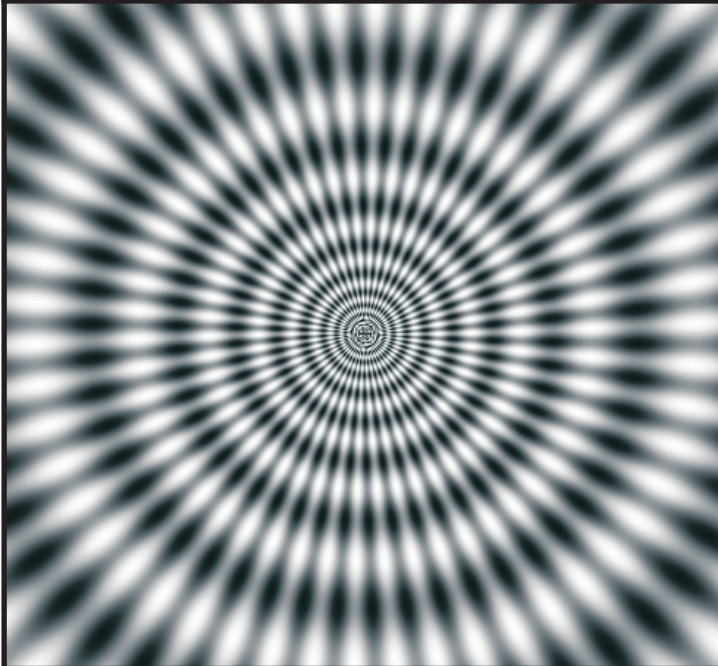
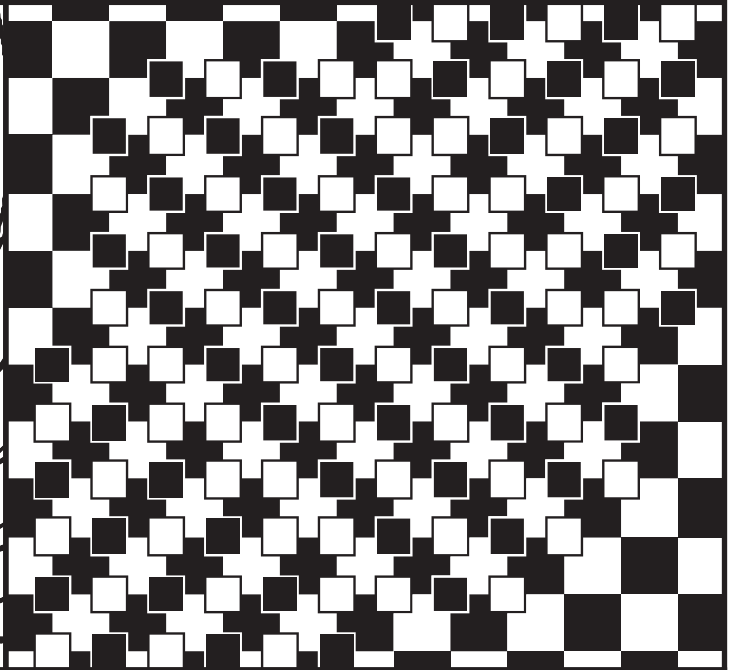
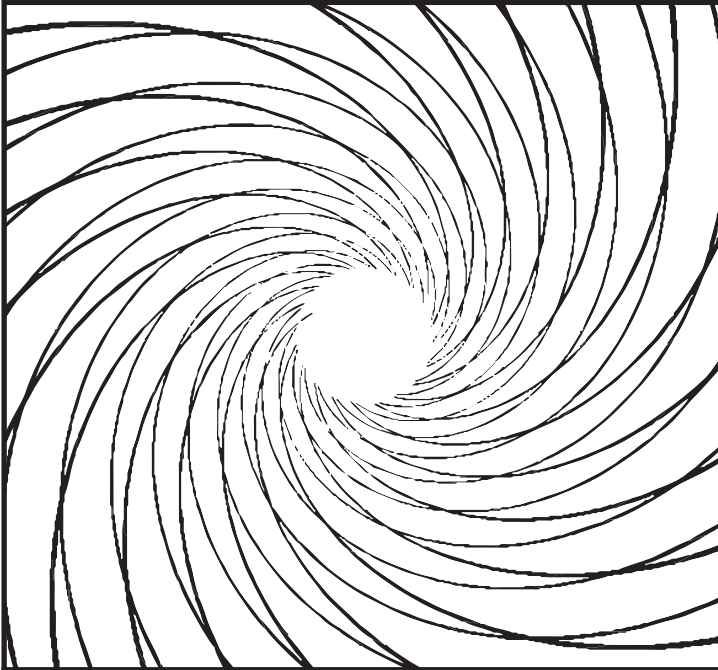

Colour each of these gemstones symmetrically.

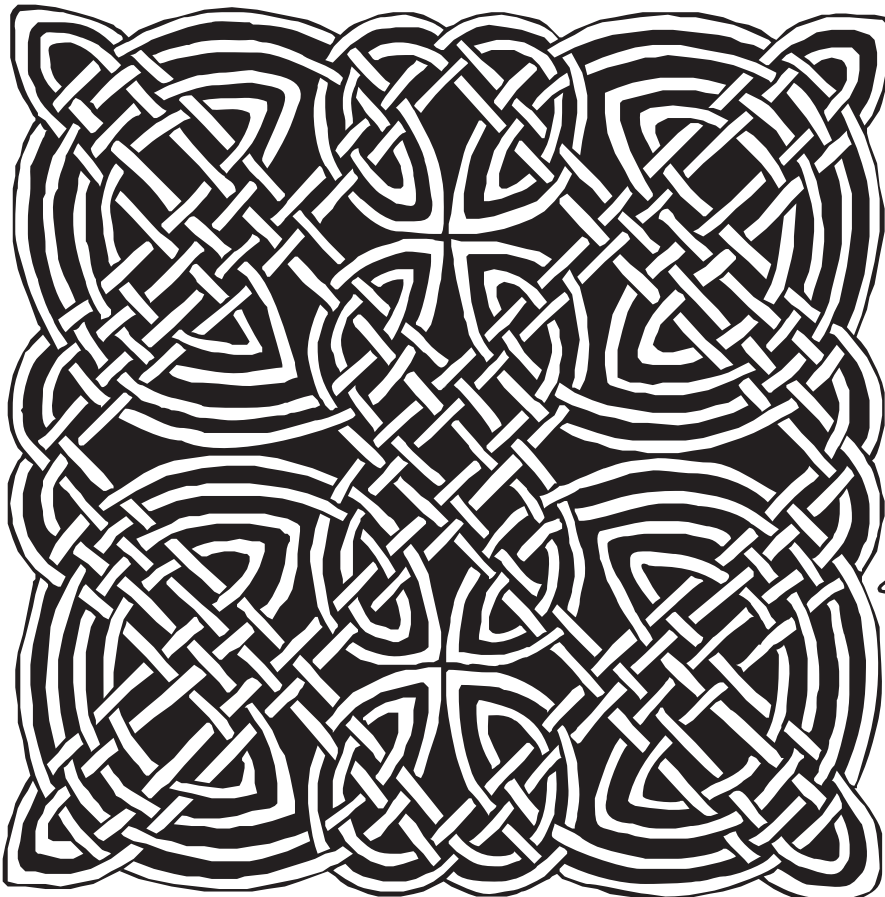
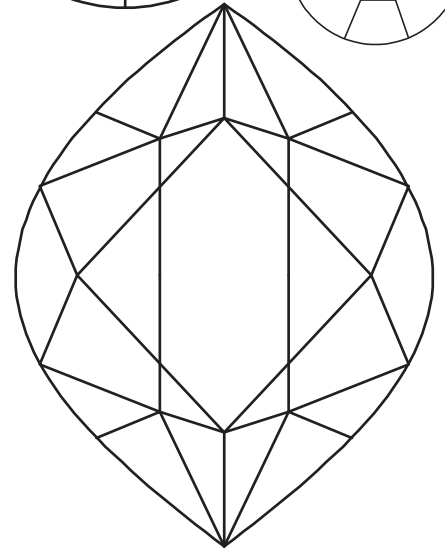
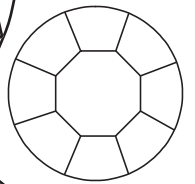
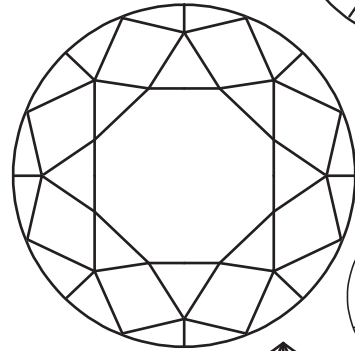
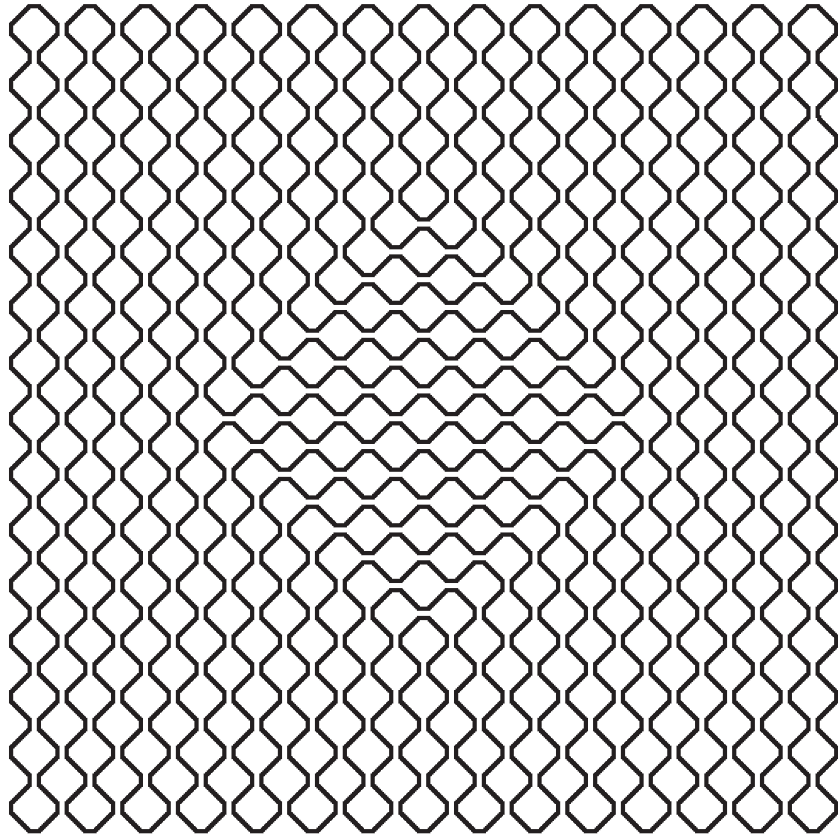
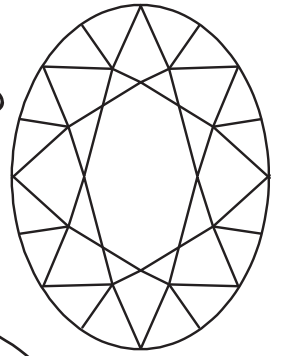
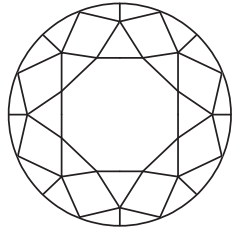
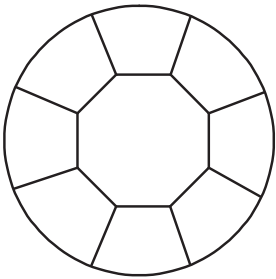

AAAAAHHHH!!



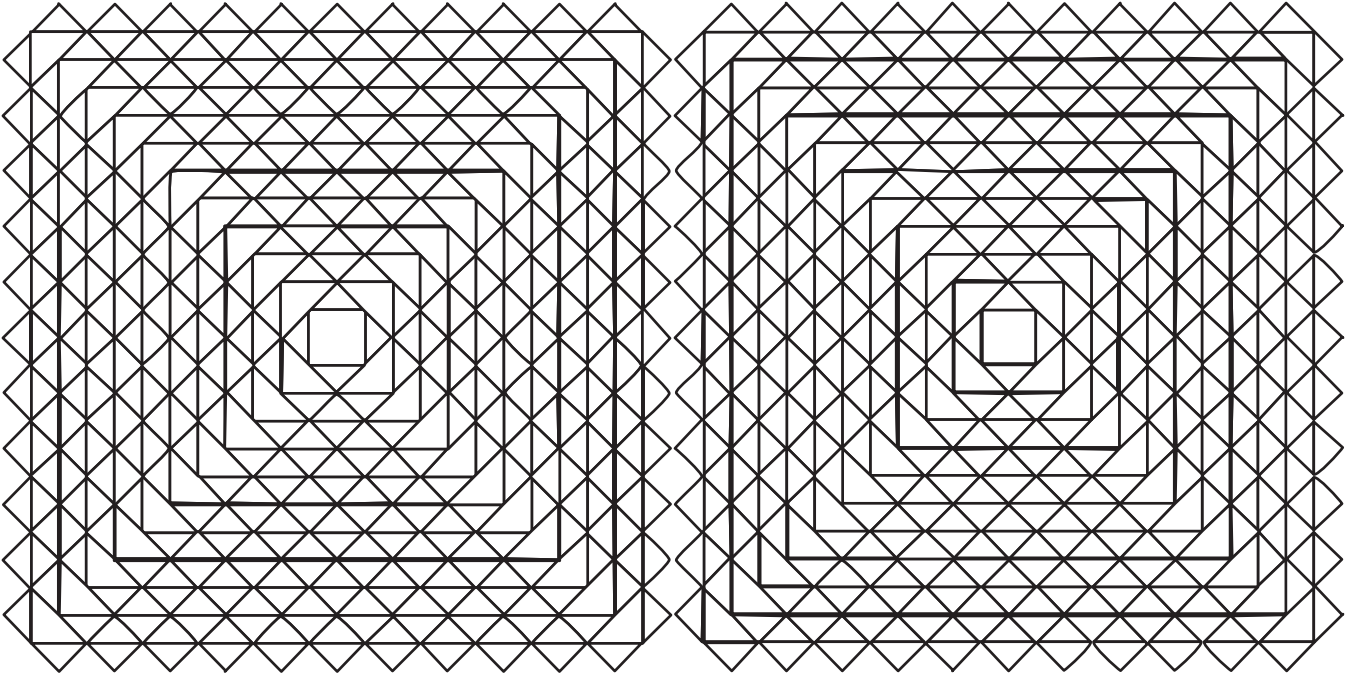
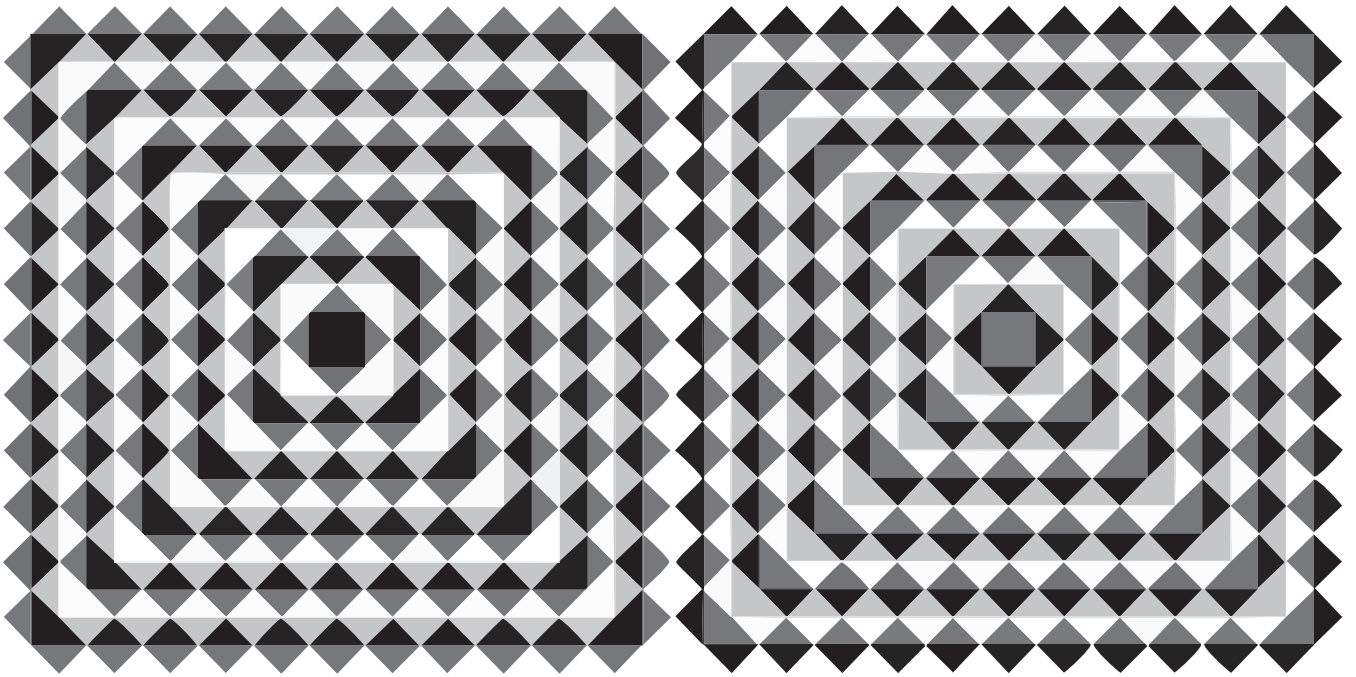

Colour the shapes above and try to match the effect of the top shapes.

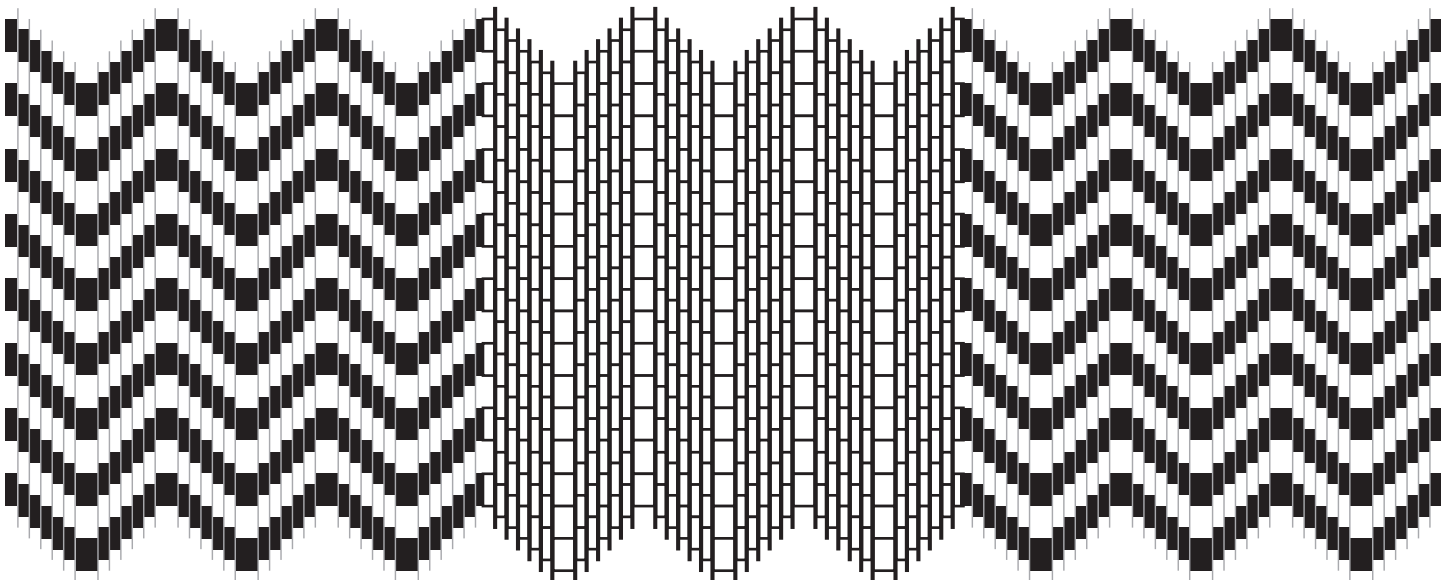

Colour the middle section to match.



CAN YOU STOMACH THIS?

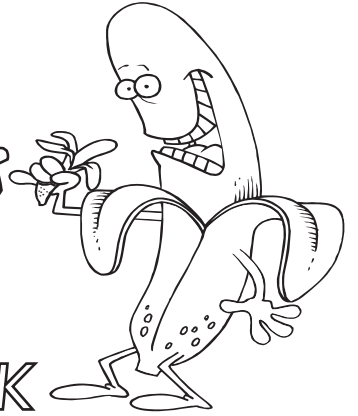

S P O O N K I T C H E N R P K
 S I S A L I M E N T A T I O N
 E N E R G Y G V I A N D S T U
 C E V Y R A N I L U C O K A J
 O C L R R T O A S T G O T B T
 R O A E L B I D E R A F N L S
 P M V K N F M E A L S T E E T
 A E I O M I O D K L T S M H T
 B S C O O A S R N L R A I C O
 U T T C U T N I K U O F R A N
 L I U E T O A N U F N Y T M G
 U B A A H P P K A C O V U O U
 M L L N O U R I S H M E N T E
 E E S W E H C O O L Y M E S S
 T E E T H P R O V E N D E R S

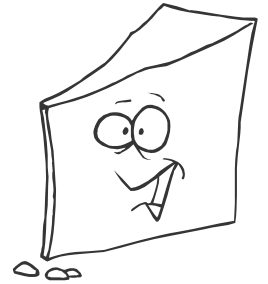

- FORK
- SPOON
- VALVES
- PANS
- CUT
- COOL
- PAIN
- OCEAN
- MESS
- RISK
- PINE

- JUNK
- MANNA
- NOURISHMENT
- NUTRIMENT
- PABULUM
- POTABLE
- VIANDS
- VICTUALS
- YOLK
- CHEWS
- STOMACH

- TONGUE
- TEETH
- MOUTH
- TASTE
- KITCHEN
- MEALS
- PROVENDER
- PROCESS
- ENERGY
- FULL
- TOAST

- ALIMENTATION
- BEVERAGE
- COMESTIBLE
- COOKERY
- CUISINE
- CULINARY
- DRINK
- EDIBLE
- FARE
- FASTFOOD
- GASTRONOMY

The left-over letters will spell an essential requirement for kitchens: _ _ _ _ _

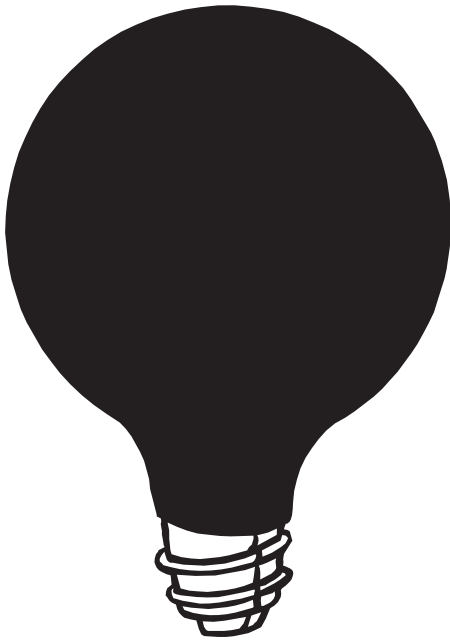

Can you see a dog in this picture?

*Stare closely at this light bulb
for 20 - 25 seconds...
Then immediately stare at a white area
on a wall or a sheet of paper.
You should see a glowing light bulb!*

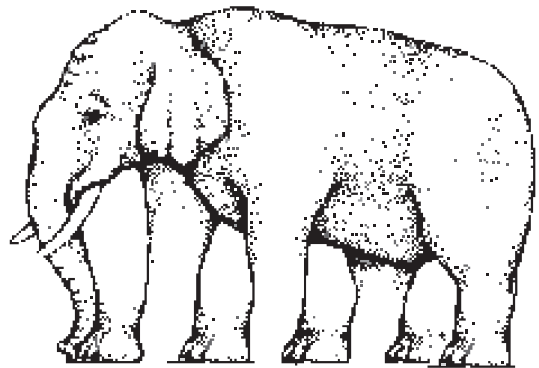

How many legs does this elephant have?

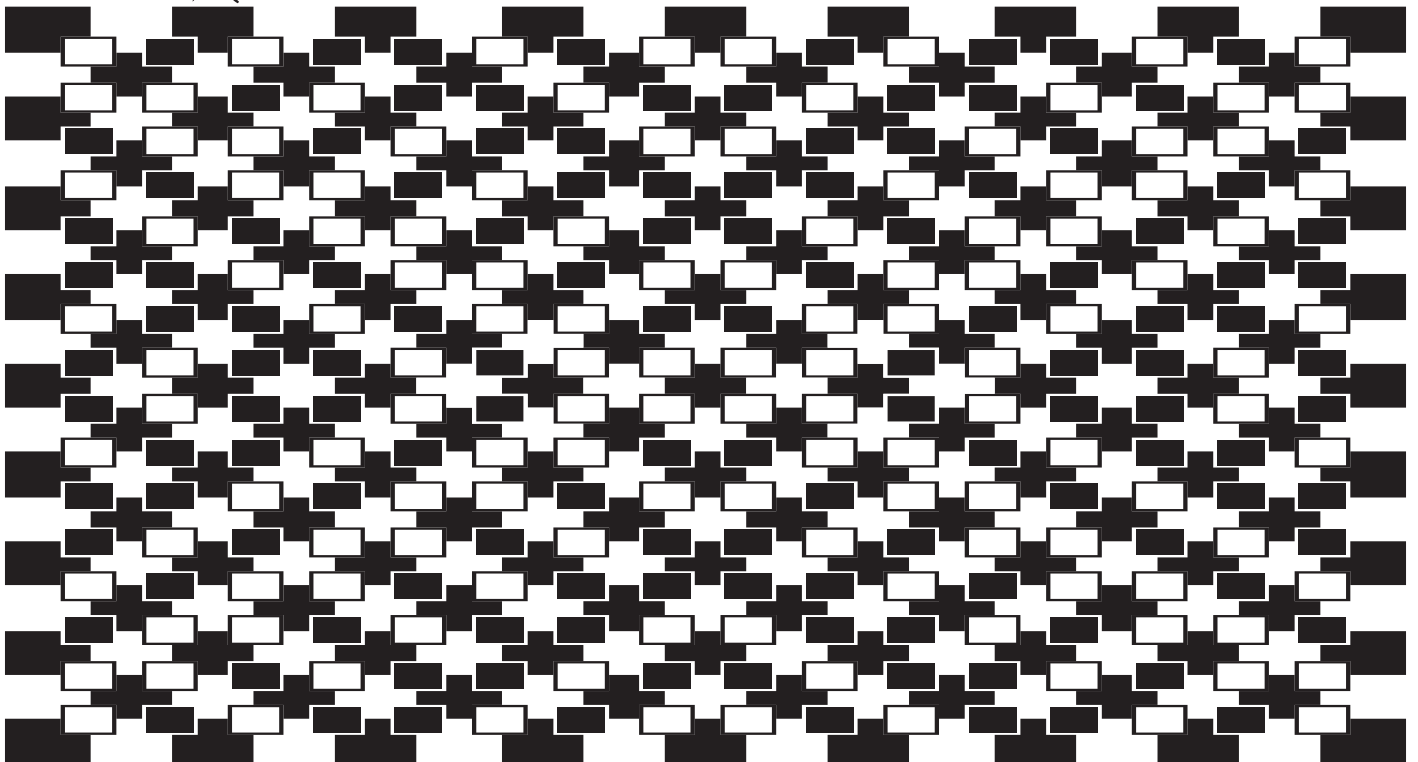

Explore these interesting designs with some colour.

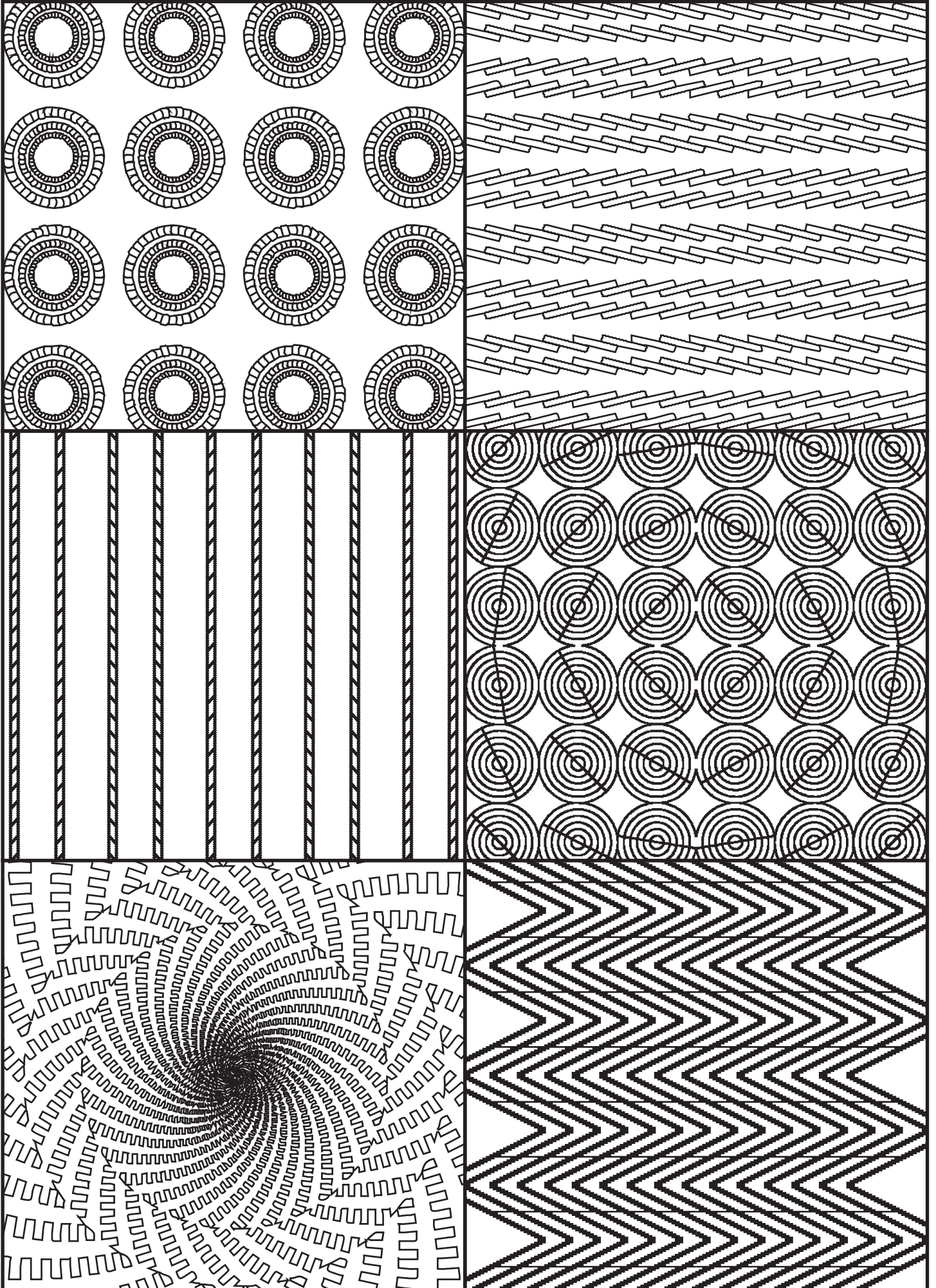

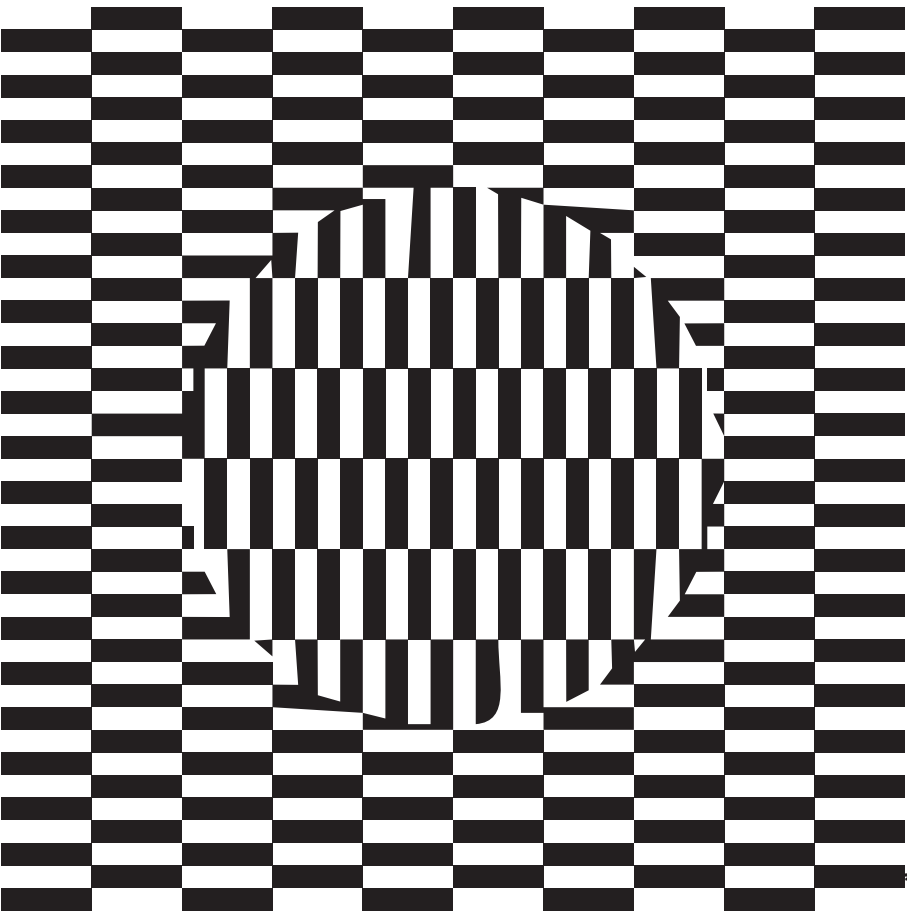
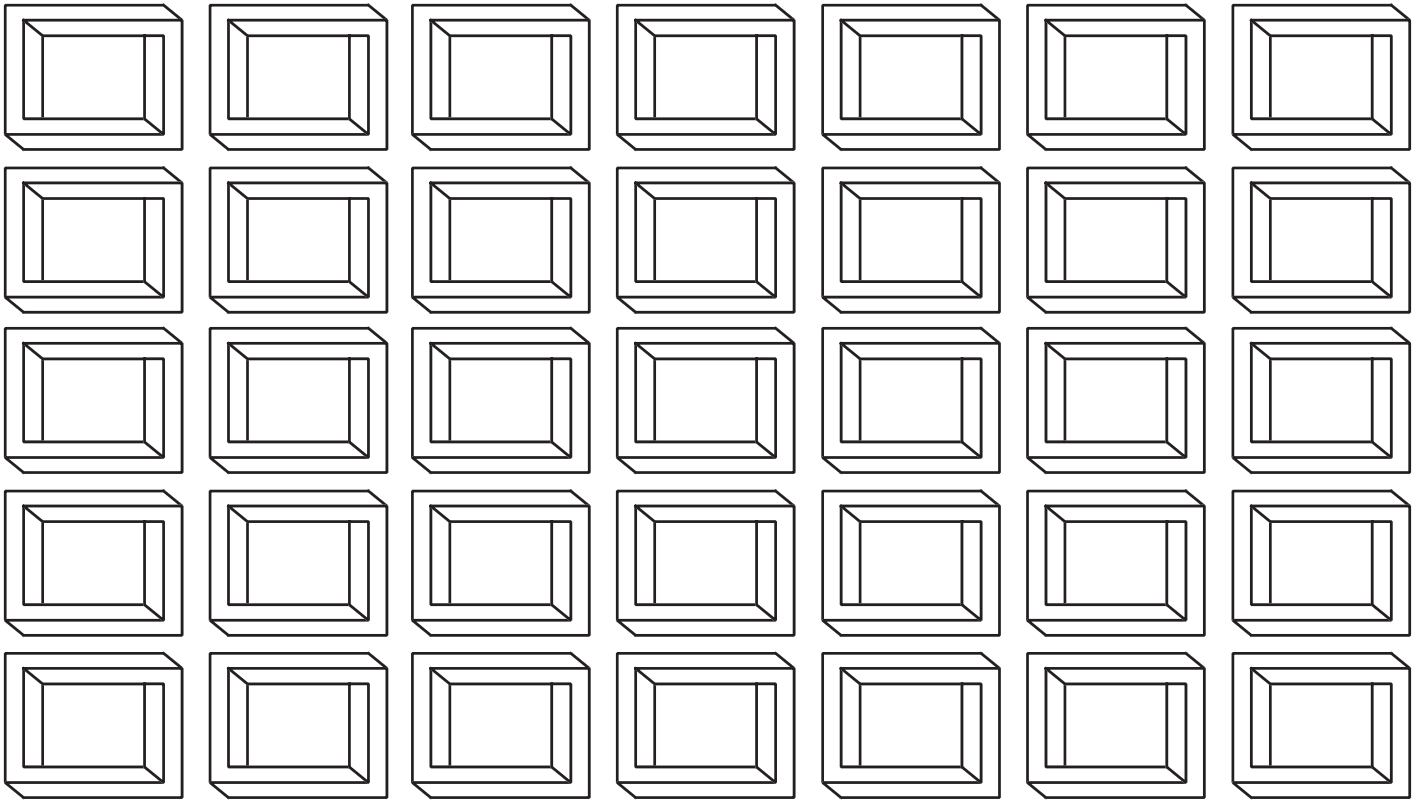

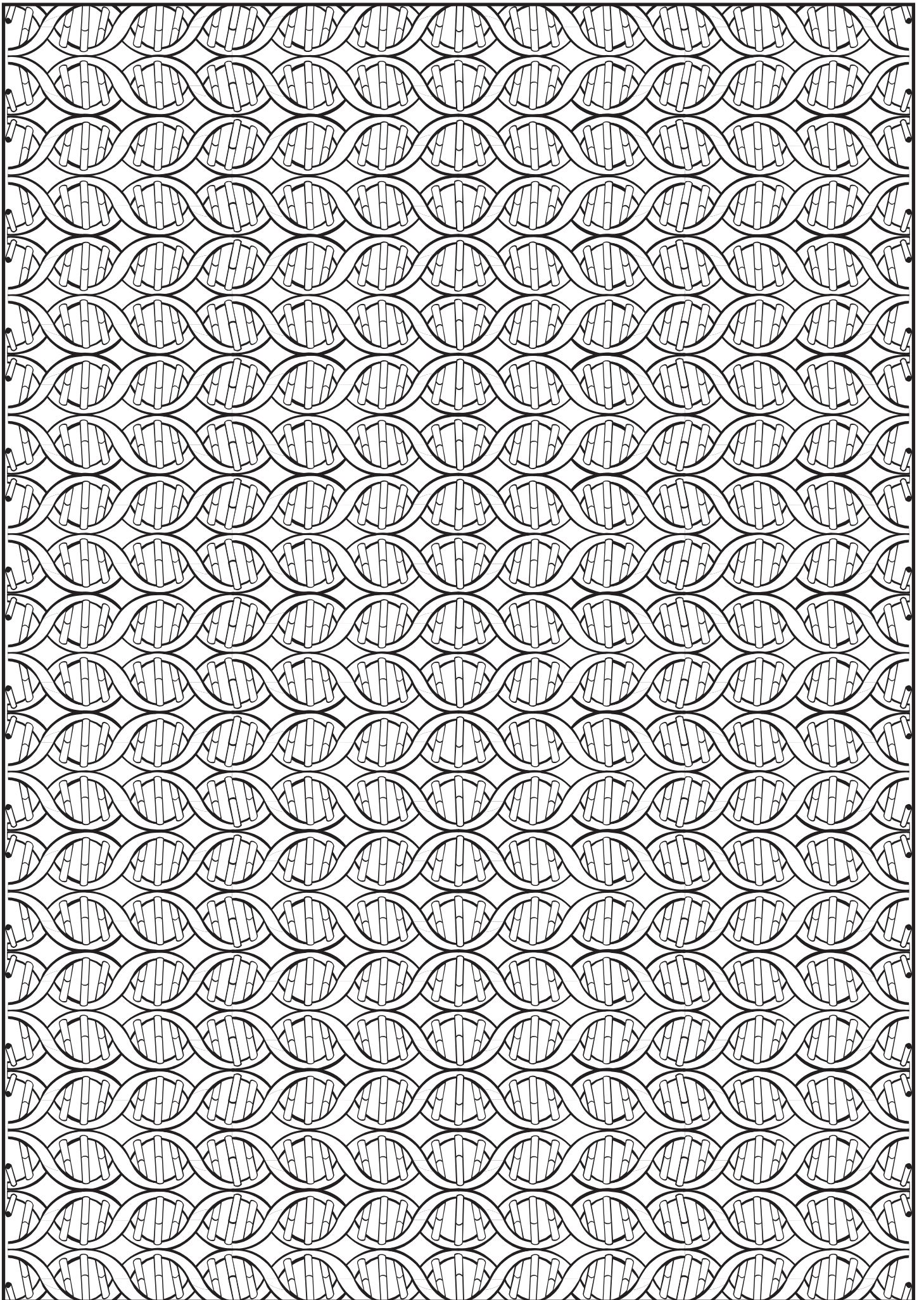

Answers

Page 10

dog, horse, cat, cow, sheep, lion, tiger, elephant, zebra, wolf, fox, tortoise, bear, snake, rhinoceros, antelope, jaguar, leopard, camel, giraffe, hippopotamus, monkey, goat, deer, crocodile

Page 13

Easy Sudoku - Puzzle 1	Easy Sudoku - Puzzle 2	Easy Sudoku - Puzzle 3	Easy Sudoku - Puzzle 4	Easy Sudoku - Puzzle 5
6 9 8 3 2 1 5 7 4	9 2 8 5 6 7 4 1 3	6 1 4 9 8 5 3 7 2	3 2 8 1 4 5 7 9 6	9 8 5 7 1 2 4 6 3
4 7 5 9 8 6 3 2 1	5 6 3 1 4 8 9 2 7	9 5 7 4 2 3 6 1 8	9 5 4 7 2 6 1 8 3	6 2 1 4 8 3 7 5 9
1 3 2 7 5 4 8 9 6	1 7 4 2 3 9 6 8 5	2 3 8 6 7 1 9 4 5	1 6 7 8 3 9 4 2 5	7 3 4 5 9 6 1 8 2
8 5 9 4 1 3 7 6 2	2 8 6 4 9 3 7 5 1	5 8 1 2 4 9 7 3 6	4 9 6 3 7 1 8 5 2	1 6 3 9 4 7 5 2 8
2 4 7 8 6 5 1 3 9	4 3 1 7 5 2 8 6 9	7 2 3 1 6 8 5 9 4	2 8 1 5 6 4 3 7 9	8 5 7 2 3 1 9 4 6
3 6 1 2 7 9 4 8 5	7 9 5 6 8 1 3 4 2	4 6 9 5 3 7 8 2 1	5 7 3 9 8 2 6 1 4	2 4 9 6 5 8 3 7 1
5 1 3 6 9 7 2 4 8	3 1 9 8 2 4 5 7 6	3 4 5 7 1 6 2 8 9	8 1 9 6 5 3 2 4 7	5 7 6 3 2 9 8 1 4
9 8 4 1 3 2 6 5 7	8 5 2 9 7 6 1 3 4	8 9 2 3 5 4 1 6 7	7 3 2 4 9 8 5 6 1	4 9 8 1 6 5 2 3 7
7 2 6 5 4 8 9 1 3	6 4 7 3 1 5 2 9 8	1 7 6 8 9 2 4 5 3	6 4 5 2 1 7 9 3 8	3 1 2 8 7 4 6 9 5

Page 32

Medium Sudoku - Puzzle 1	Medium Sudoku - Puzzle 2	Medium Sudoku - Puzzle 3	Medium Sudoku - Puzzle 4	Medium Sudoku - Puzzle 5
6 4 9 1 5 2 7 8 3	7 8 1 4 2 9 6 5 3	6 5 1 4 3 9 8 2 7	6 2 7 4 5 3 1 8 9	1 9 6 8 2 3 5 7 4
1 3 7 6 8 4 5 9 2	5 9 6 7 3 1 2 8 4	2 4 8 5 7 6 1 9 3	3 9 1 2 8 7 4 6 5	7 3 2 5 9 4 8 6 1
5 8 2 7 9 3 4 1 6	3 2 4 6 8 5 1 9 7	7 3 9 8 2 1 4 5 6	5 4 8 9 6 1 2 3 7	8 4 5 6 1 7 2 9 3
3 7 4 9 2 8 6 5 1	1 3 2 5 7 6 8 4 9	3 6 5 1 8 2 9 7 4	2 6 9 8 1 4 7 5 3	2 7 4 1 5 8 6 3 9
2 5 1 4 3 6 8 7 9	8 4 5 2 9 3 7 6 1	9 2 7 6 5 4 3 1 8	1 7 4 5 3 9 8 2 6	9 6 8 3 4 2 1 5 7
9 6 8 5 7 1 3 2 4	9 6 7 1 4 8 3 2 5	1 8 4 7 9 3 2 6 5	8 3 5 6 7 2 9 1 4	3 5 1 7 6 9 4 8 2
8 1 5 3 4 9 2 6 7	6 5 8 9 1 7 4 3 2	8 1 6 9 4 5 7 3 2	4 5 2 3 9 8 6 7 1	6 8 7 4 3 1 9 2 5
4 2 6 8 1 7 9 3 5	2 1 9 3 6 4 5 7 8	5 7 2 3 1 8 6 4 9	9 1 6 7 2 5 3 4 8	5 1 9 2 7 6 3 4 8
7 9 3 2 6 5 1 4 8	4 7 3 8 5 2 9 1 6	4 9 3 2 6 7 5 8 1	7 8 3 1 4 6 5 9 2	4 2 3 9 8 5 7 1 6

Page 36

Dr. Schweitzer always spared small non-human life. A bee that had flown indoors would be captured by a drinking glass, some cardboard underneath it, and released. He would step aside rather than crush an ant, a beetle, a worm.

Page 40

Hard Sudoku - Puzzle 1	Hard Sudoku - Puzzle 2	Hard Sudoku - Puzzle 3	Hard Sudoku - Puzzle 4	Hard Sudoku - Puzzle 5
7 9 6 5 4 8 2 1 3	3 2 5 7 4 9 1 8 6	8 1 5 4 2 6 7 9 3	1 9 6 8 2 3 5 7 4	9 8 4 1 5 7 3 6 2
2 1 5 3 6 9 8 4 7	1 4 7 6 8 5 2 9 3	4 7 6 1 9 3 2 8 5	7 3 2 5 9 4 8 6 1	3 2 6 9 4 8 5 7 1
3 8 4 7 1 2 9 6 5	9 8 6 2 3 1 7 4 5	3 2 9 5 7 8 4 1 6	8 4 5 6 1 7 2 9 3	1 5 7 2 3 6 8 4 9
5 7 8 9 3 4 1 2 6	7 6 9 3 2 8 5 1 4	6 9 2 8 5 7 3 4 1	2 7 4 1 5 8 6 3 9	6 1 3 5 9 4 2 8 7
4 3 9 6 2 1 5 7 8	8 1 4 5 6 7 3 2 9	1 8 7 3 4 9 5 6 2	9 6 8 3 4 2 1 5 7	5 9 8 7 2 3 6 1 4
6 2 1 8 7 5 3 9 4	2 5 3 1 9 4 8 6 7	5 4 3 6 1 2 8 7 9	3 5 1 7 6 9 4 8 2	7 4 2 6 8 1 9 3 5
1 4 3 2 5 7 6 8 9	4 3 1 8 5 6 9 7 2	7 5 4 2 6 1 9 3 8	6 8 7 4 3 1 9 2 5	8 3 9 4 1 5 7 2 6
9 6 7 1 8 3 4 5 2	6 7 2 9 1 3 4 5 8	9 6 8 7 3 5 1 2 4	5 1 9 2 7 6 3 4 8	2 6 1 3 7 9 4 5 8
8 5 2 4 9 6 7 3 1	5 9 8 4 7 2 6 3 1	2 3 1 9 8 4 6 5 7	4 2 3 9 8 5 7 1 6	4 7 5 8 6 2 1 9 3

‘Primary Puzzles and Patterns’ provides many interesting and varied activities to develop the skills of visual and spatial perception as well as encouraging the development of problem solving and thinking skills.

Activities include:

- * Word searches on varied topics.
- * Symmetry and tessellations.
- * Optical illusions and mazes.
- * Shapes and colour.
- * The activities will encourage the students to use different thinking strategies in order to solve various questions and puzzles.

This book is suitable for the following grades in different states.

	NSW	ACT	VIC	TAS	WA	NT	SA	QLD	NZ	
K, Prep										
1										LOWER
2										
3	✓	✓	✓	✓						MIDDLE
4	✓	✓	✓	✓	✓	✓	✓	✓	✓	
5	✓	✓	✓	✓	✓	✓	✓	✓	✓	UPPER
6					✓	✓	✓	✓	✓	

7

Burrabooks publications are written by Australian teachers who have had extensive classroom experience.

For more information visit:

www.burrabooks.com.au



BURRABOOKS

www.burrabooks.com.au
mail@burrabooks.com.au