

'Crafty Word Families' has craft activities for each "word family" sounds.

- *Activities include - tracing, colouring, cutting and pasting and circling the correct sounds.
- *The activities use basic materials that are available in every classroom.
- *The word family sounds treated are:
- ab, ad, an, am, ag, at, ap, id, ig, it, ob, og
op, ot, ub, ug, um, un, ut, ed, en.

This book is suitable for the following grades in different states.

	NSW	ACT	VIC	TAS	WA	NT	SA	QLD	NZ	
K, Prep	✓	✓	✓	✓						LOWER MIDDLE UPPER
1					✓	✓	✓	✓	✓	
2										
3										
4										
5										
6										
7										

Burrabooks publications are written by Australian teachers who have had extensive classroom experience.

For more information visit:

www.burrabooks.com.au

BUR-2010



9 781922 234247



CRAFTY WORD FAMILIES



AUSTRALIAN EDUCATIONAL PUBLISHERS

CRAFTY

WORD FAMILIES



Crafty Word Families

written by Louise and Amy Porich

© Burrabooks Pty Ltd.

First Published 2020

ABN 22 070 006 085

P. O. Box 611

Moruya NSW 2537

Ph: 02 4474 2355

www.burrabooks.com.au

louise@burrabooks.com.au

All rights reserved.

COPYING FOR EDUCATIONAL AND OTHER PURPOSES

Except as permitted by the copyright applicable to you, you may not reproduce or communicate any of the content of this book without the permission of the copyright owner. The Australian Copyright Act allows certain uses of content without the copyright owner's permission. This includes by educational institutions and by Commonwealth and State Governments, provided compensation is paid. For more information, see www.copyright.com.au and www.copyright.org.au. The owners of copyright of this content may receive compensation for the use of their content by educational institutions, including from licensing schemes managed by the Copyright Agency.

Some images used with permission of Ron Leishman.

Visit www.toonaday.com for more information.

As with all Burrabooks publications every attempt is made to acknowledge copyright. Any infringements are purely coincidental and the publisher offers apologies where applicable.

ISBN: 978-1-922234-22-3

www.burrabooks.com.au
mail@burrabooks.com.au
Latest books, news & more.

BUR-2010

BURRABOOKS

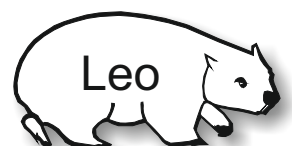

Introduction













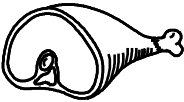
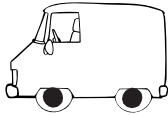

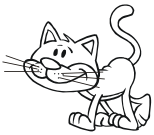



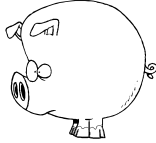

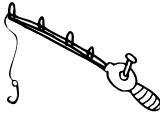

‘Crafty Word Families’ has craft activities for each “word family” sounds.

*Activities include - tracing, colouring, cutting and pasting and circling the correct sounds.

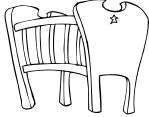
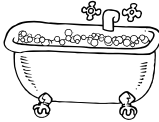

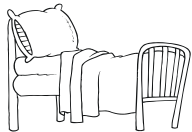
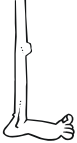

*The activities use basic materials that are available in every classroom.

*The word family sounds treated are:

- ab, ad, an, am, ag, at, ap, id, ig, it, ob, og
op, ot, ub, ug, um, un, ut, ed, en.

 cab	 dad	 bag	 ham	 van	 tap
 cat	 fax	 bib	 lid	 pig	 Tim
 fin	 lip	 sit	 sob	 rod	 dog
 top	 cot	 tub	 mug	 mum	 sun
 hut	 bed	 leg	 hen	 jet	

ab

-  Trace the **ab** sound.
-  Colour in the taxi cab.
-  Trace the **ab** sounds in the sentence.
-  Circle the **ab** sounds.

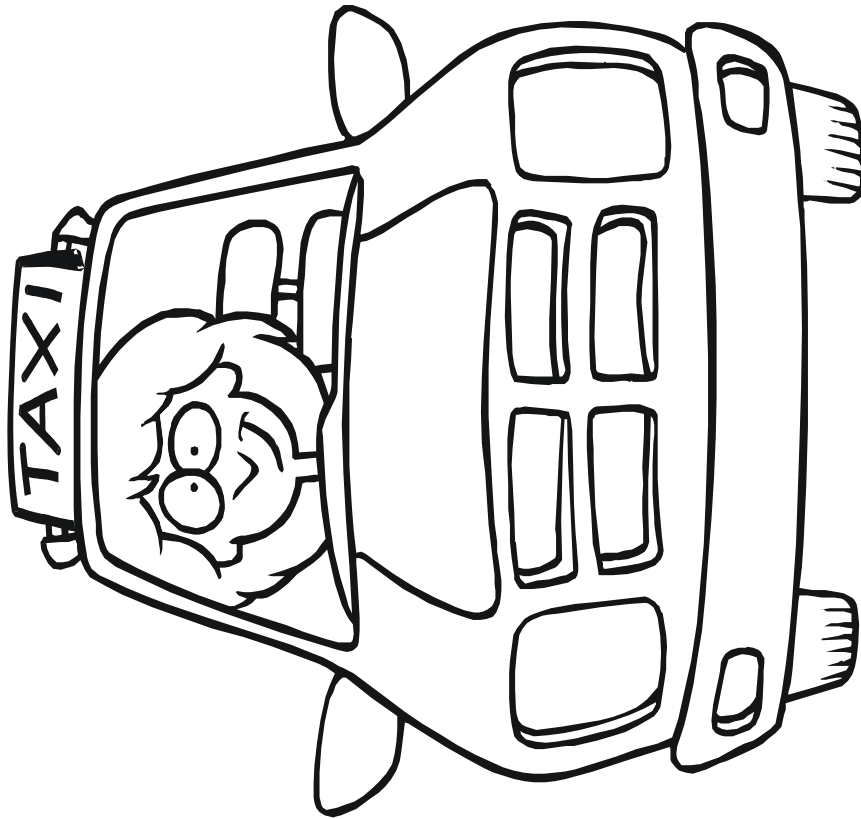

Crabs on a cab.

 Trace the **ab** words.

 Colour the crabs.

 Cut them out and paste on and around the cab.

dab

tab

cab

jab

Crabs on a cab.



tab

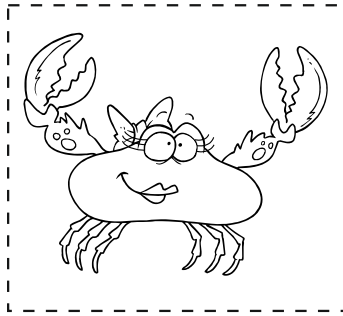

jab



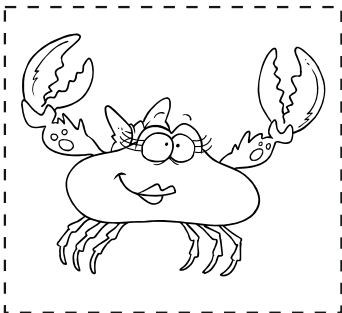
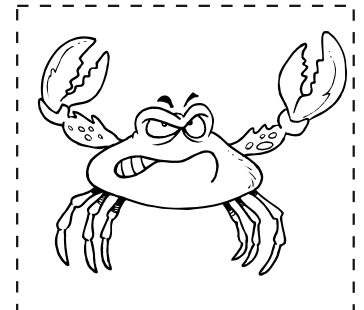
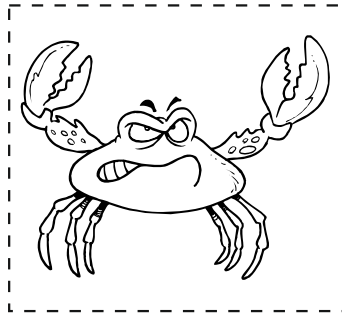

cab



lab



dab

ad

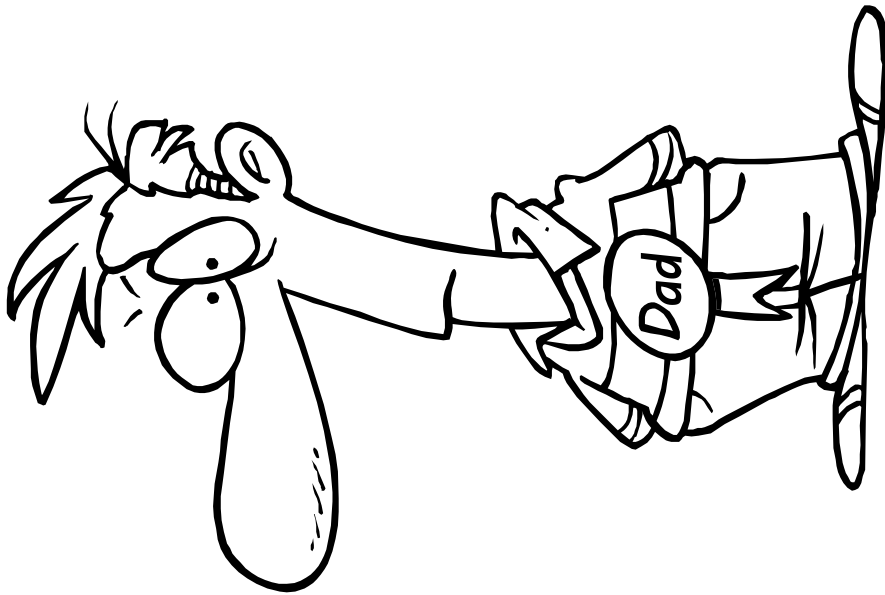
-  Trace the **ad** sound.
-  Colour the picture of dad.
-  Trace the **ad** sounds in the sentence.
-  Circle the **ad** sounds.



Dad is mad at the bad lads.

 Trace the **ad** words.
 Colour the lads.
 Cut them out and paste
around Dad.

pad had mad

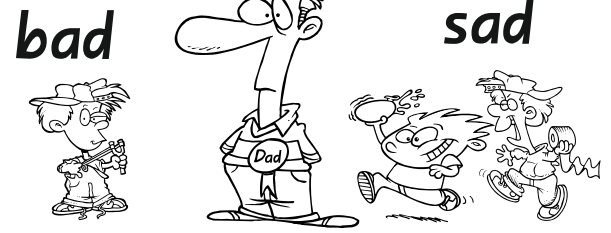

Dad is mad at the bad lads.

bad



mad





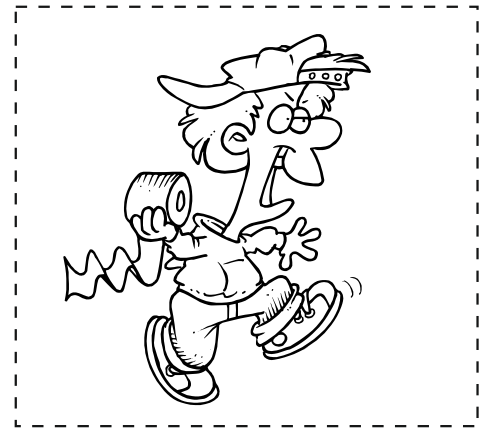

had



pad



sad

an

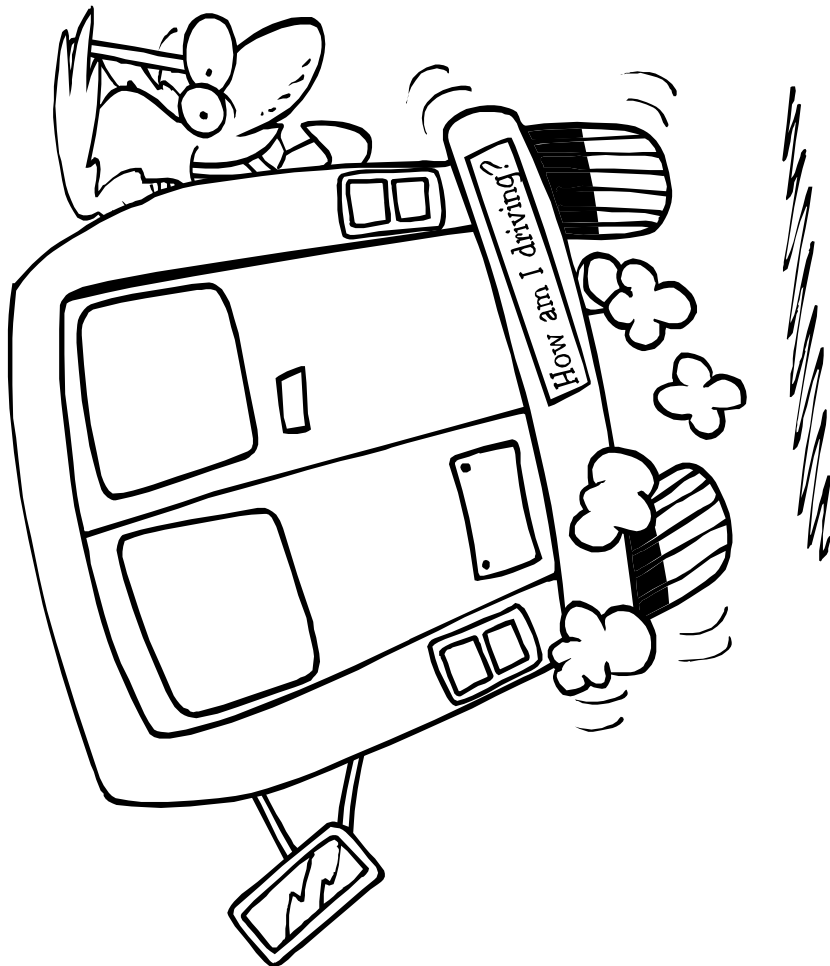
-  Trace the **an** sound.
-  Colour the van.
-  Trace the **an** sounds in the sentence.
-  Circle the **an** sounds.



Cans near a van.

 Trace the **an** words.
 Colour the cans.
 Cut them out and paste
around the van.

fan man pan
tan ran
ban



Cans near a van.

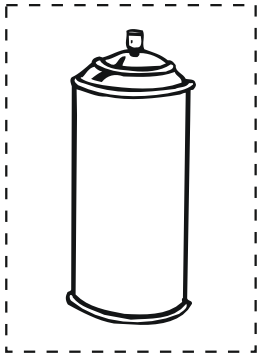

fan

man

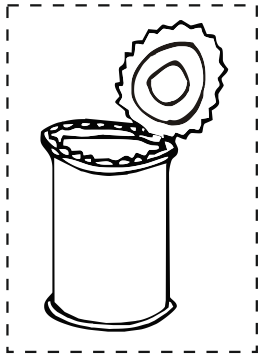

pan

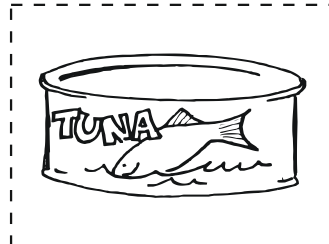
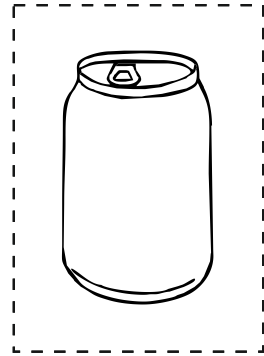

ran

ban

tan

am

 Trace the **am** sound.

 Colour Sam.

 Trace the **am** sounds in the sentence.

 Circle the **am** sounds.

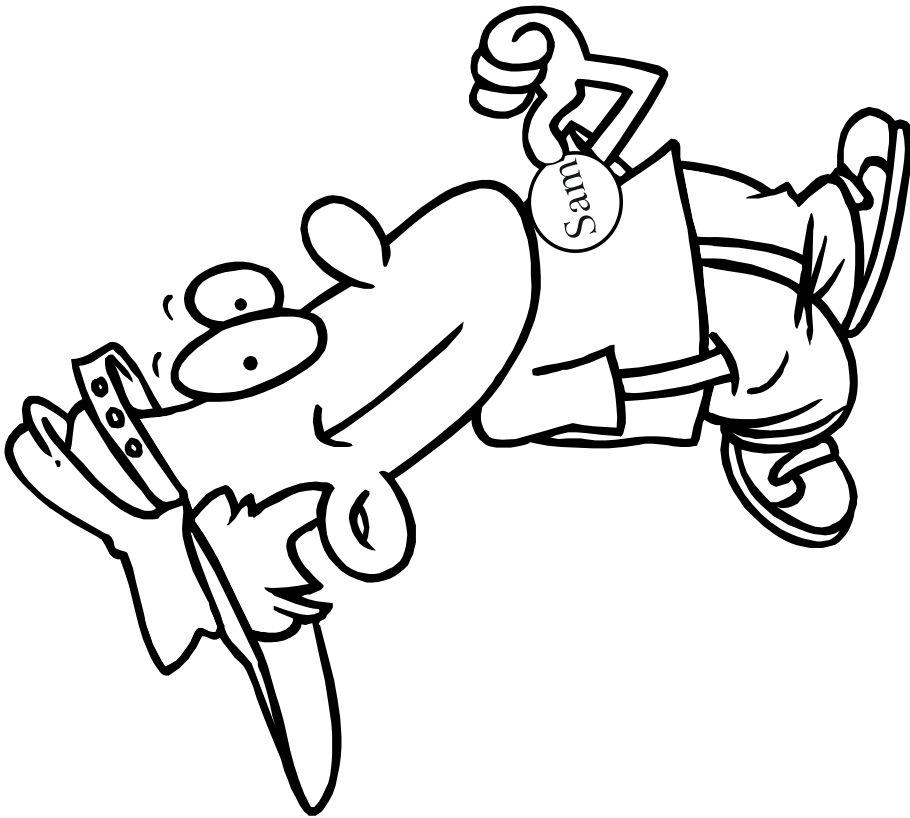

Sam has lots of **hams**.

 Trace the **am** words.

 Colour the hams.

 Cut them out and paste around Sam.

dam

ram

jam

yam



Sam has lots of hams.

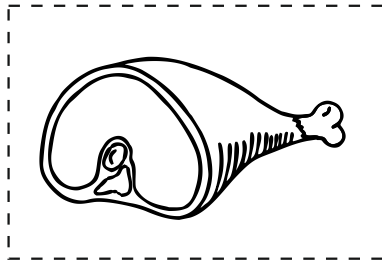
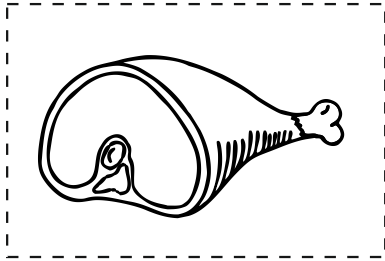

man

jam

ram

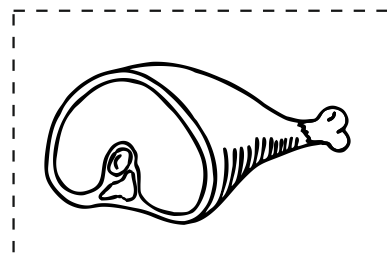
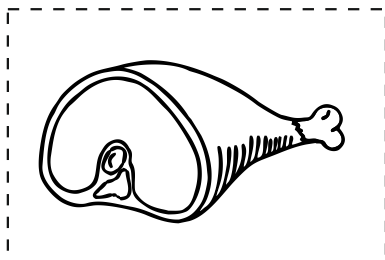
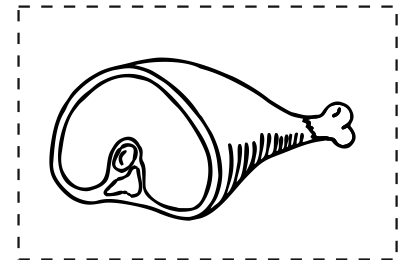

yam

dam

ag

 Trace the **ag** sound.

 Colour mum.

 Trace the **ag** sounds in the sentence.

 Circle the **ag** sounds.

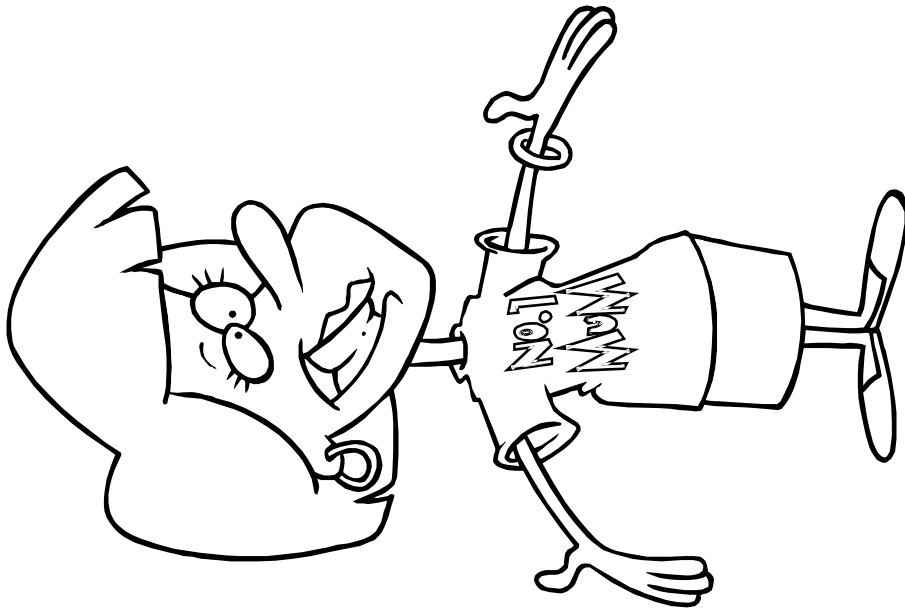

Mum has baags with tags.

 Trace the **ag** words.

 Colour the bags and tags.

 Cut them out and paste around mum.

rag

wag

nag

sag



Mum has bags with tags.



rag

wag

nag



sag

at

 Trace the **at** sound.

 Colour the cat.

 Trace the **at** sounds in the sentence.

 Circle the **at** sounds.

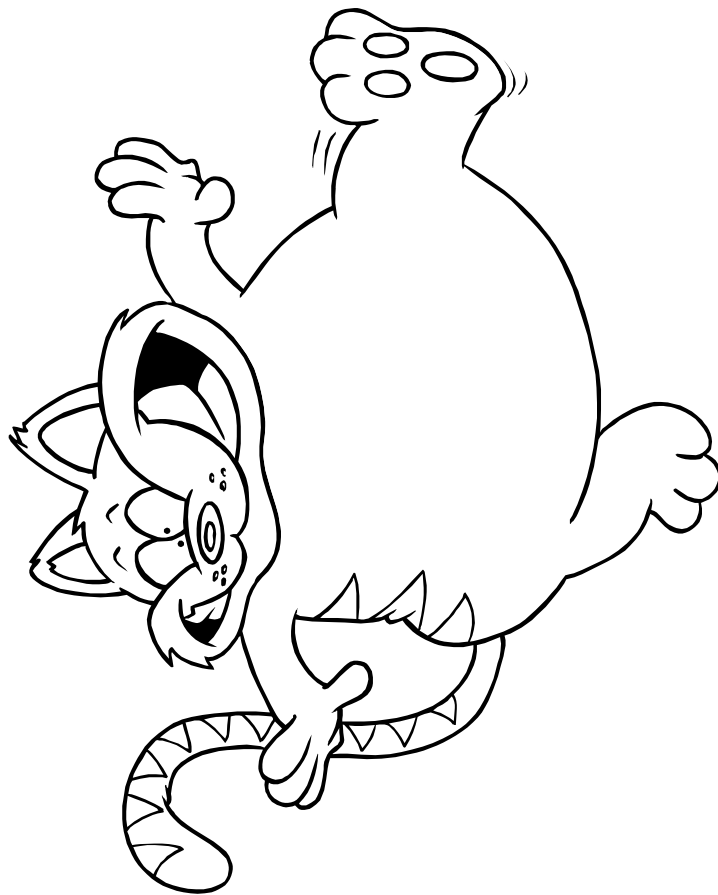

A fat cat with hats.

 Trace the **at** words.

 Colour the hats.

 Cut them out and paste around the fat cat.

rat mat pat
bat sat

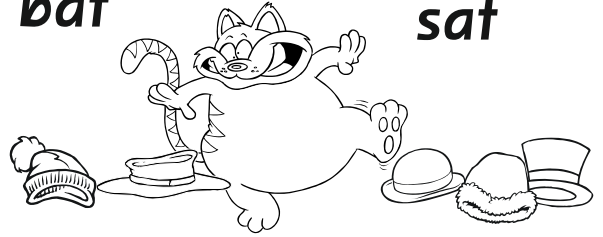

A fat cat with hats.

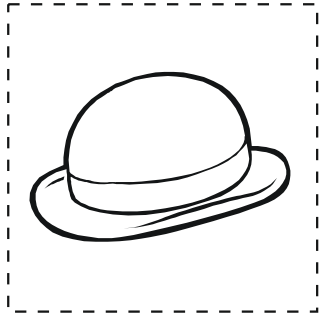

rat

mat

pat

bat

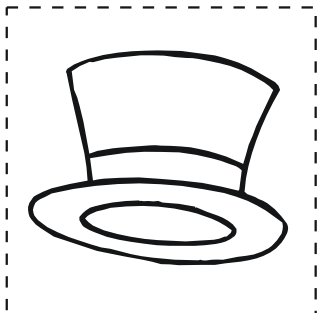
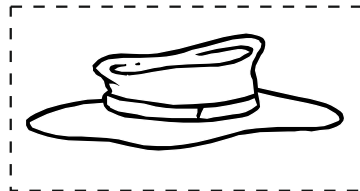

sat

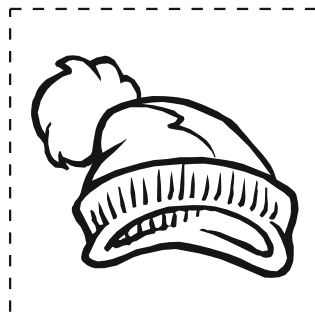

ap

 Trace the **ap** sound.

 Colour the cap.

 Trace the **ap** sounds in the sentence.

 Circle the **ap** sounds.

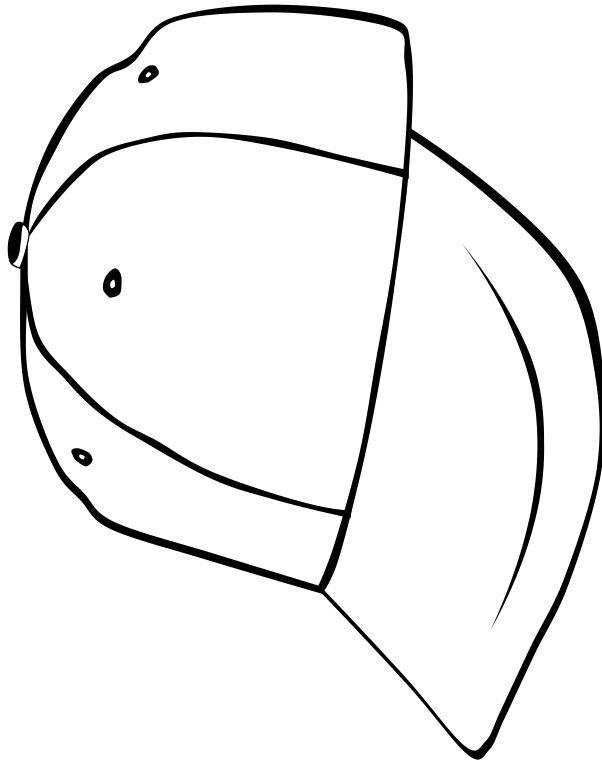

Taps near a cap.

 Trace the **ap** words.

 Colour the taps.

 Cut them out and paste around the cap.

map

sap

nap

gap

lap

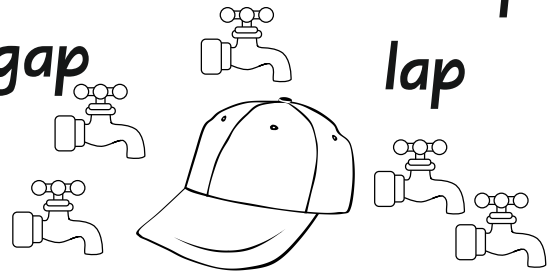

Taps near a cap.

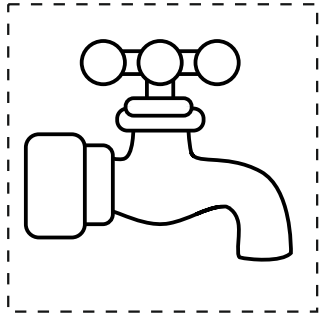

map

nap

gap

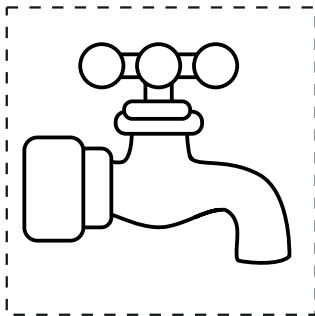
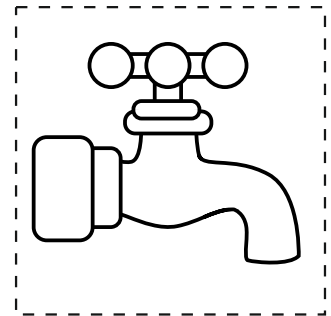
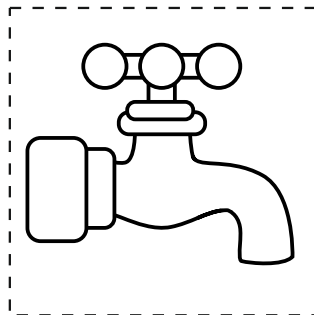

lap

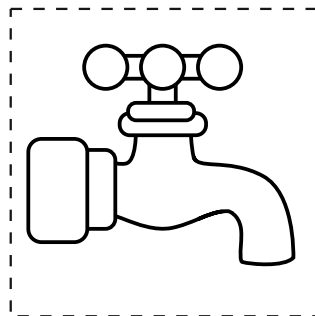

sap

id

 Trace the **id** sound.

 Colour the kid.

 Trace the **id** sounds in the sentence.

 Circle the **id** sounds.

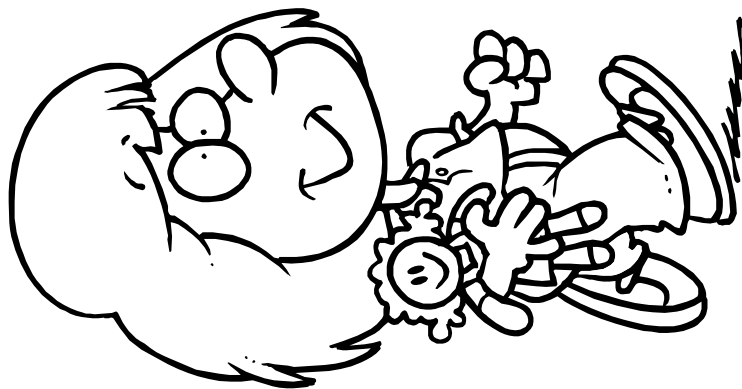

Lids around a kid.

 Trace the **id** words.

 Colour the lids.

 Cut them out and paste around the kid.

did rid bid hid

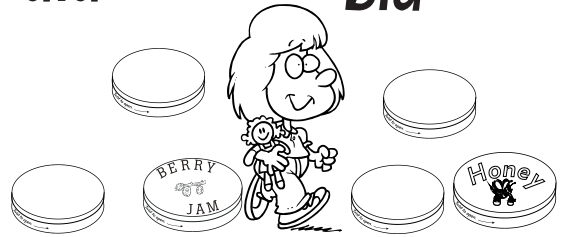

Lids around a kid.

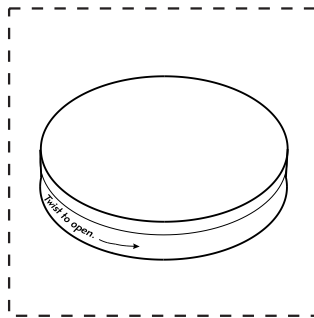
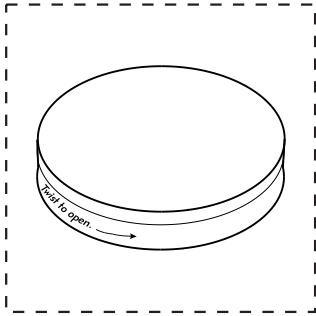

hid

did

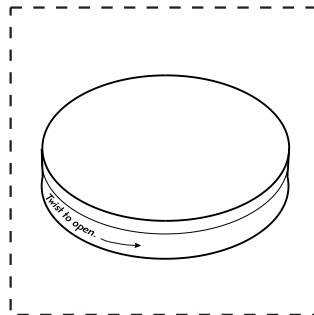

bid

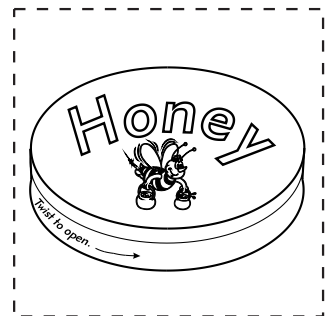
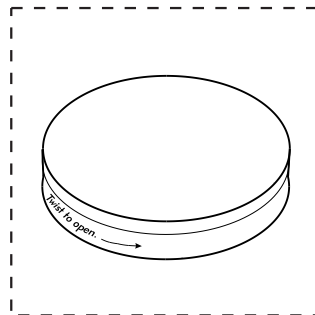
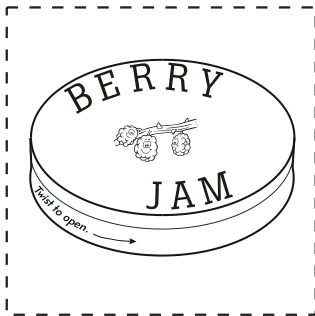

rid

ig

 Trace the **ig** sound.



 Colour the pig.

 Trace the **ig** sounds in the sentence.

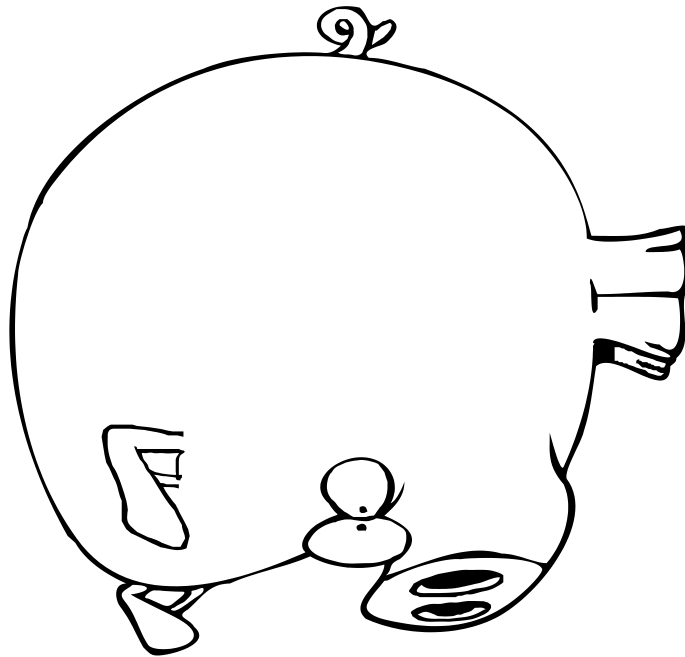
 Circle the **ig** sounds.



Wigs around a **big** pig.

 Trace the **ig** words.
 Colour the wigs.
 Cut them out and paste
around the pig.



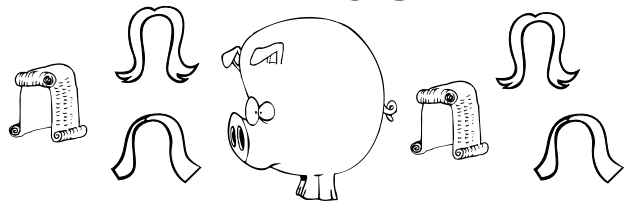

dig fig jig big

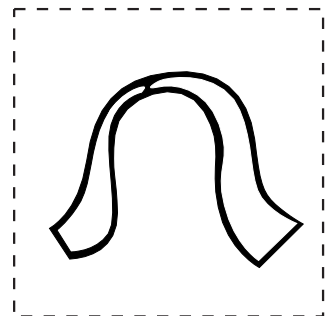
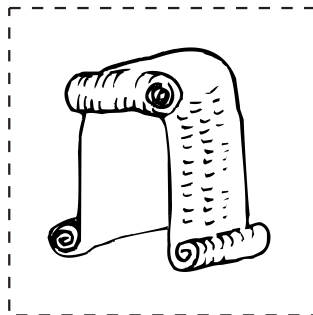
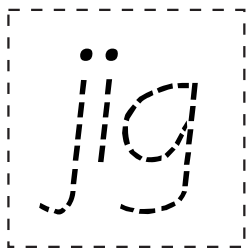
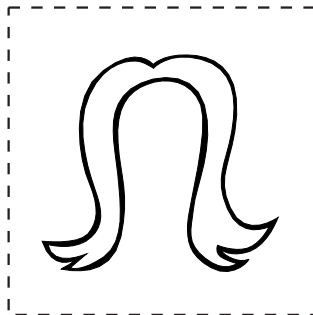
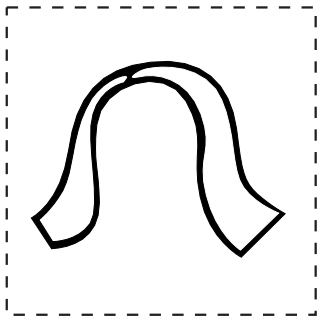
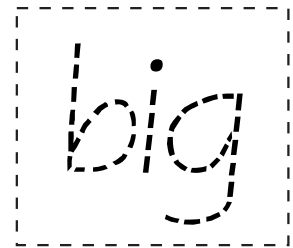
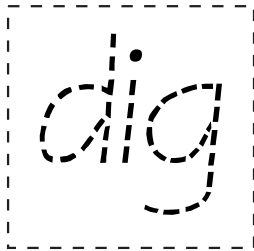
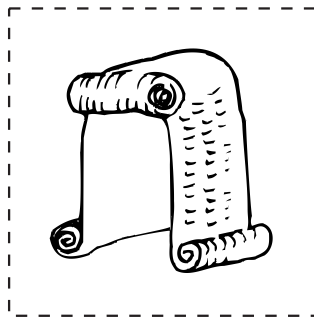
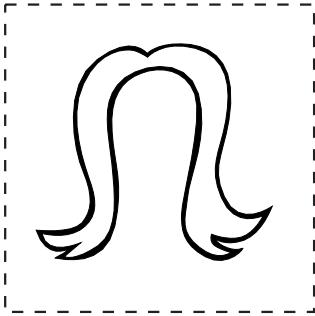

Wigs around a big pig.



in

-  Trace the **in** sound.
-  Colour the bin.
-  Trace the **in** sounds in the sentence.
-  Circle the **in** sounds.

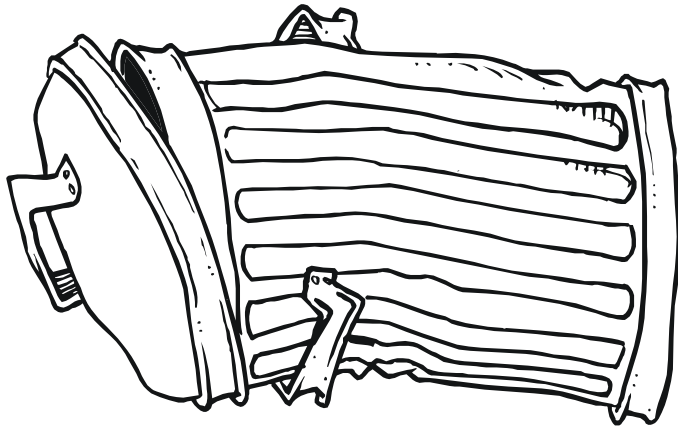

Pins near the bin.

 Trace the **in** words.

 Colour the pins.

 Cut them out and paste around the bin.

tin din win fin

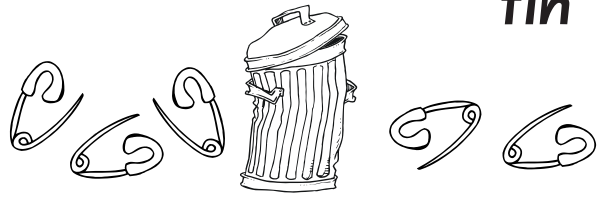

Pins near the bin.



fin

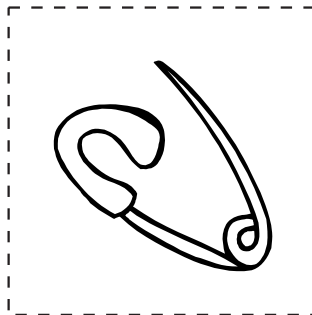
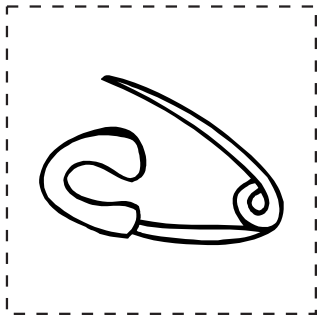
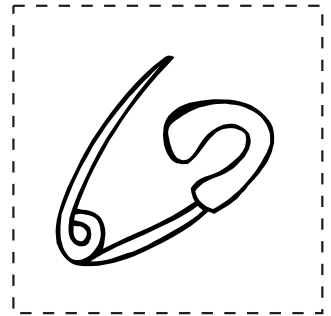

win

tin

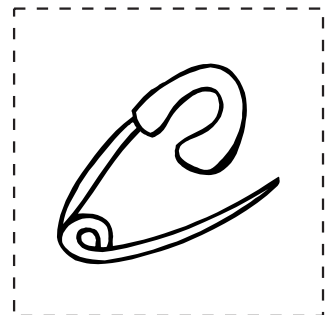
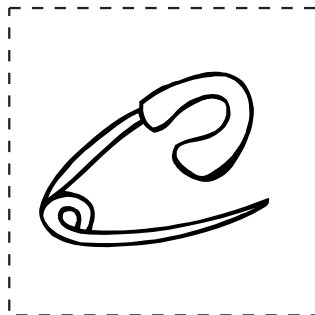

din

it

 Trace the **it** sound.

 Colour the pit.

 Trace the **it** sounds in the sentence.

 Circle the **it** sounds.



Dogs **sit** near a **pit**.

 Trace the **it** words.

 Colour the dogs.

 Cut them out and paste around the pit.



Dogs sit near a pit.

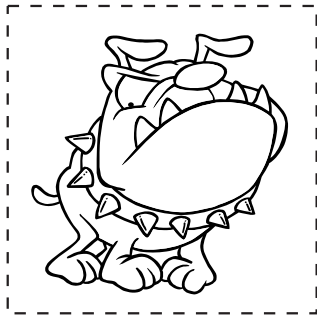

lit

bit

hit

sit

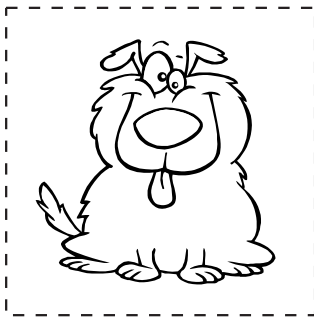
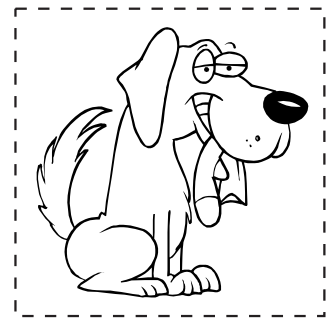

fit

kit

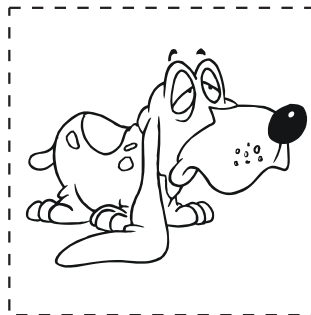

ob

 Trace the **ob** sound.

 Colour **Bob**.

 Trace the **ob** sounds in the sentence.

 Circle the **ob** sounds.

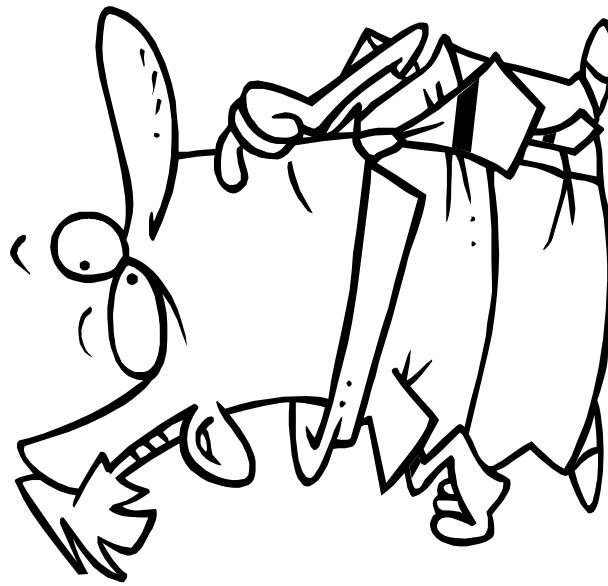

Corn cobs around Bob.

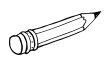

Trace the **ob** words.

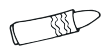

Colour the corn cobs.



Cut them out and paste around Bob.

mob

dob

sob

job

rob



lob



Corn cobs around Bob.

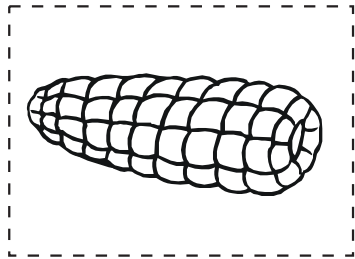

mob

rob

sob

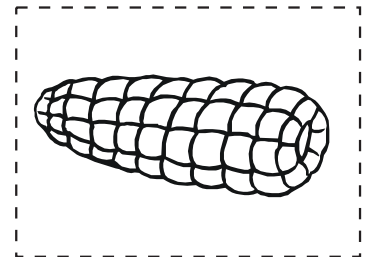
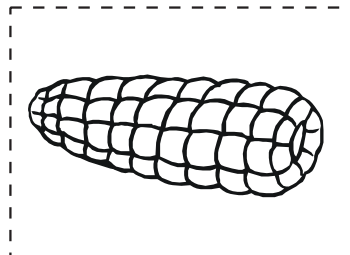

job

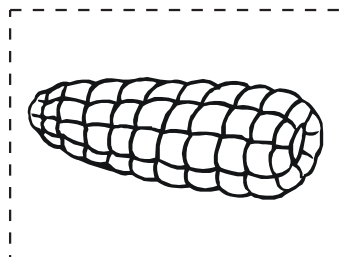

lob

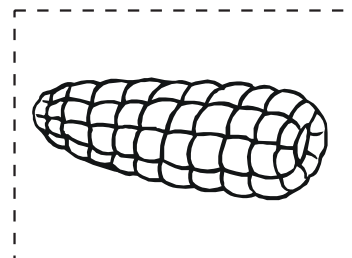
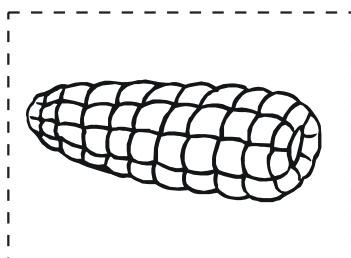

og

 Trace the **og** sound.



 Colour the logs.

 Trace the **og** sounds in the sentence.

 Circle the **og** sounds.



Dogs sit on logs.

 Trace the **og** words.
 Colour the dogs.
 Cut them out and paste
on top of the logs.

bog   dog
hog   log
fog   cog
Dogs sit on logs.

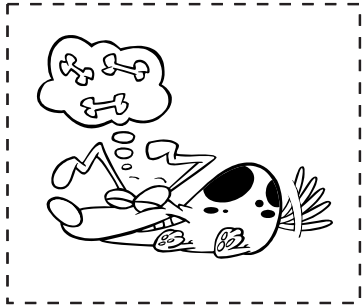

log

hog

fog

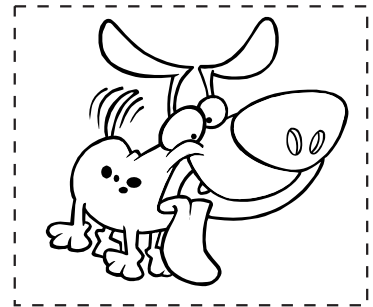



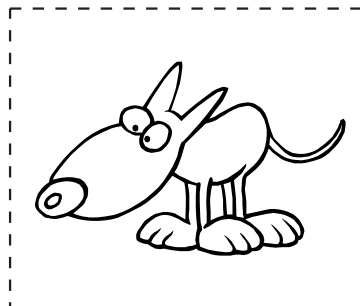

cog

dog

bog



op

-  Trace the **op** sound.
-  Colour the bowl.
-  Trace the **op** sounds in the sentence.
-  Circle the **op** sounds.

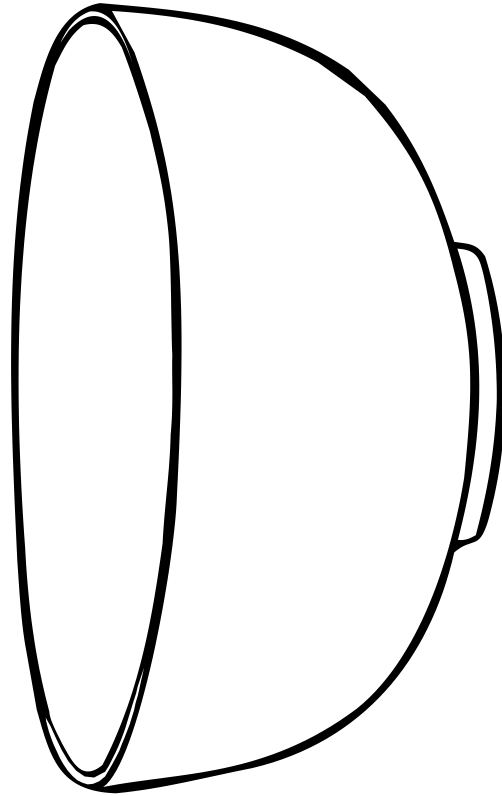

The popcorn goes pop.

 Trace the **op** words.

 Colour the popcorn.

 Cut them out and paste in and around the bowl.

pop mop
hop top
lop sop



The popcorn goes pop.

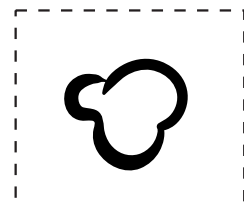
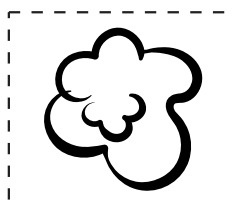
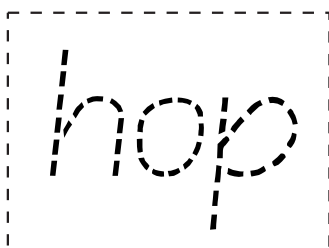
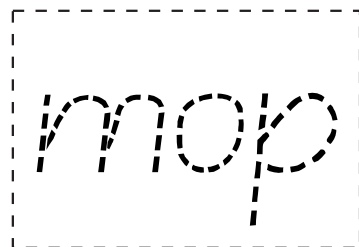
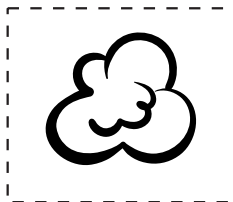
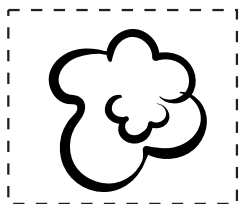
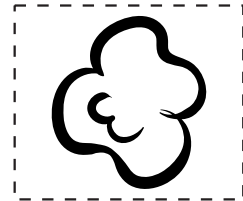
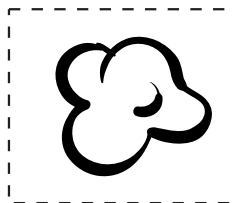
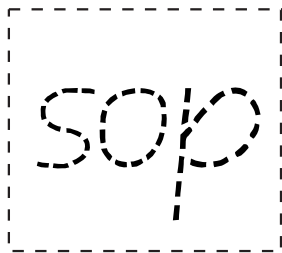
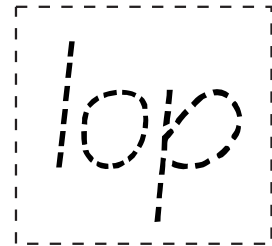
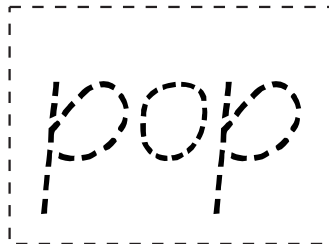
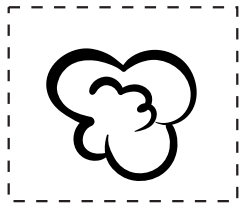

ot

 Trace the **ot** sound.

 Colour the cot.

 Trace the **ot** sounds in the sentence.

 Circle the **ot** sounds.

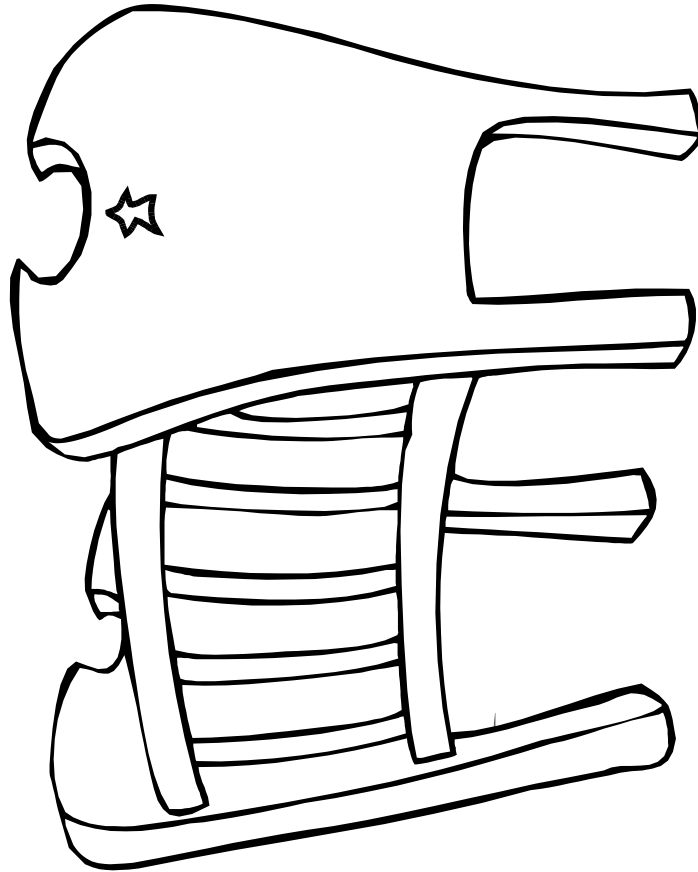

Lots of dots on a cot.

 Trace the **ot** words.

 Colour the dots.

 Cut them out and paste them on and around the cot.

rot pot not lot

hot got

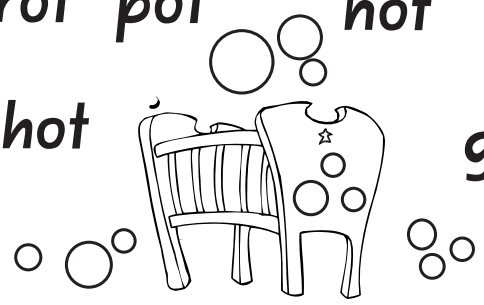

Lots of dots on a cot.

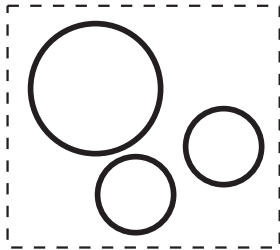

pot

not

got

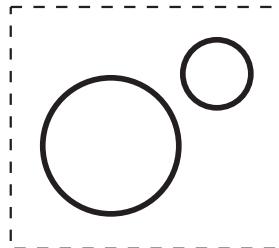

lot



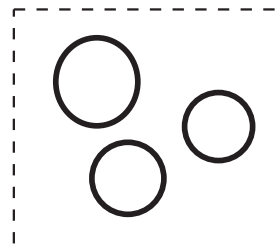

rot

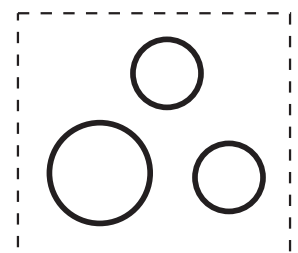
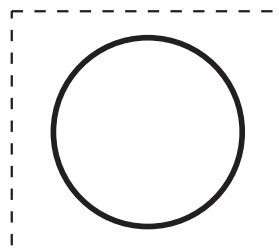

hot



ub

-  Trace the **ub** sound.
-  Colour the tub.
-  Trace the **ub** sounds in the sentence.
-  Circle the **ub** sounds.

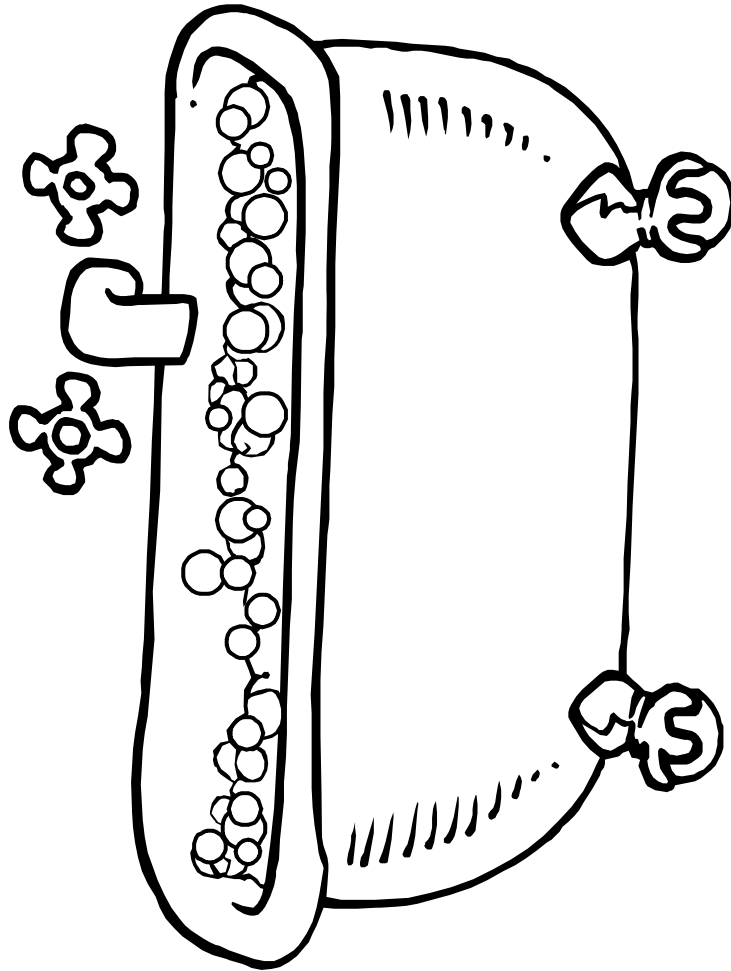

Bub**s** in a **t**ub.

 Trace the **ub** words.

 Colour the bubs.

 Cut them out and paste on and around the tub.

rub sub pub tub

bub cub

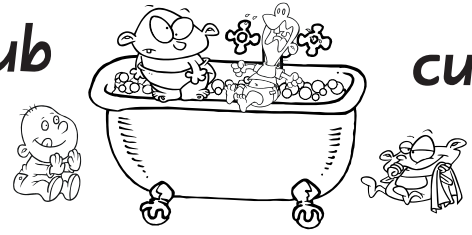

Bubs in a tub.

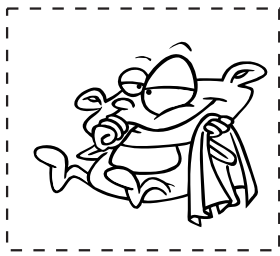

rub

sub

bub

pub

tub

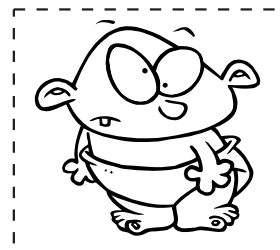

cub

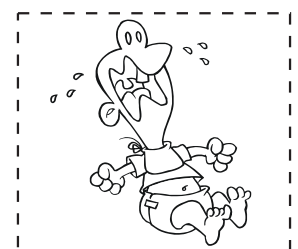
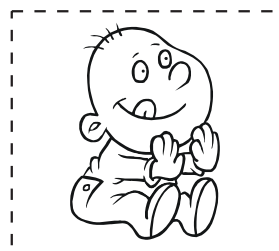

ug

 Trace the **ug** sound.

 Colour the mug.

 Trace the **ug** sounds in the sentence.

 Circle the **ug** sounds.

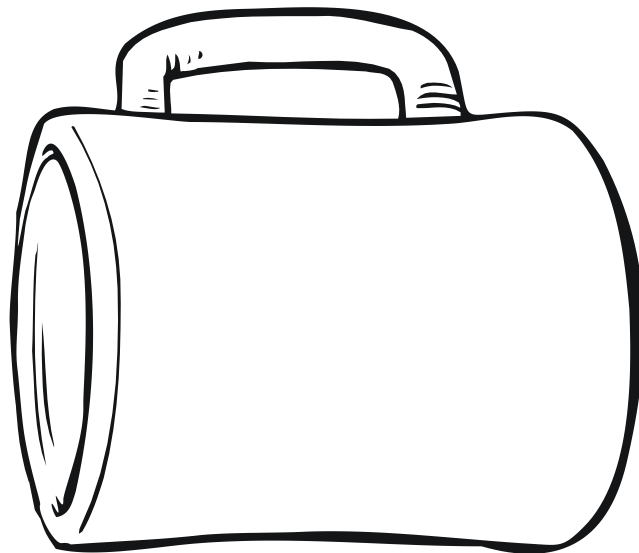

Bugs in a mug.

um

 Trace the **um** sound.

 Colour the mum.

 Trace the **um** sounds in the sentence.

 Circle the **um** sounds.

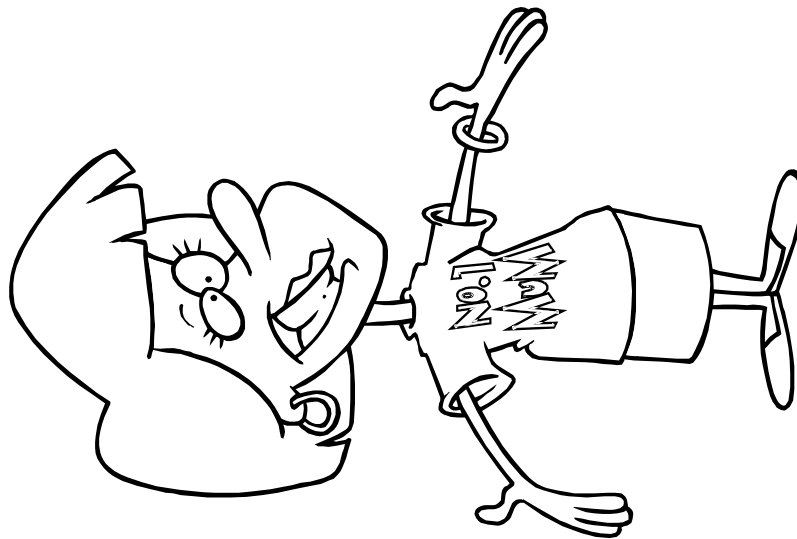

Mum does lots of **sums**.

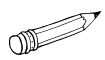

Trace the **um** words.

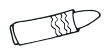

Trace over the sums.

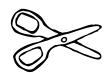

Cut them out and paste around mum.

mum gum hum

yum

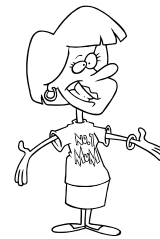

$4 + 4 = 8$

sum

$6 + 6 = 12$

$2 + 5 = 7$

$5 + 5 = 10$

$3 + 6 = 9$

Mum does lots of sums.

$2 + 5 = 7$

mum

$3 + 6 = 9$

yum

$5 + 5 = 10$

sum

$4 + 4 = 8$

$6 + 6 = 12$

hum

gum

un

 Trace the **un** sound.



 Colour the sun.

 Trace the **un** sounds in the sentence.

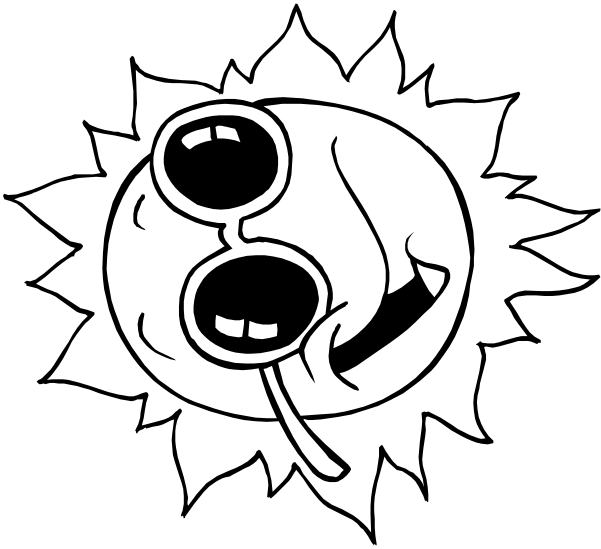
 Circle the **un** sounds.



Lots of fun in the sun.

 Trace the **un** words.
 Colour the pictures .
 Cut them out and paste
under the sun.

sun bun
gun fun nun
 sun

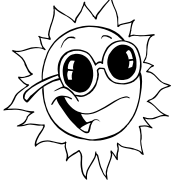
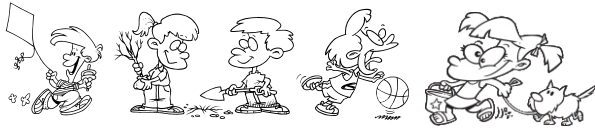
Lots of fun in the sun.

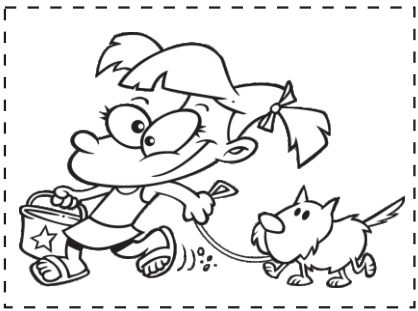

bun

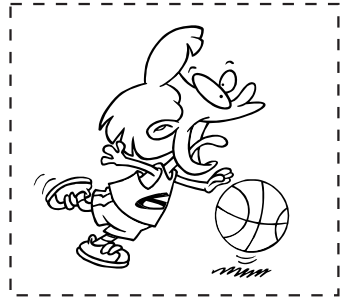

sun

fun

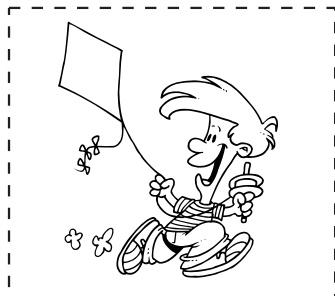

run

nun

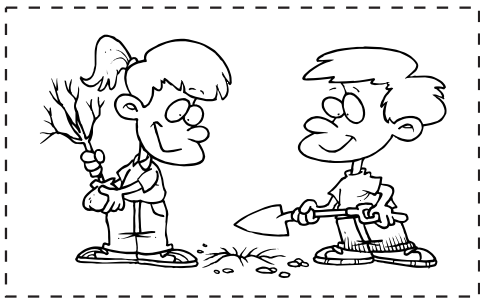

gun

ut

 Trace the **ut** sound.

 Colour the hut.

 Trace the **ut** sounds in the sentence.

 Circle the **ut** sounds.

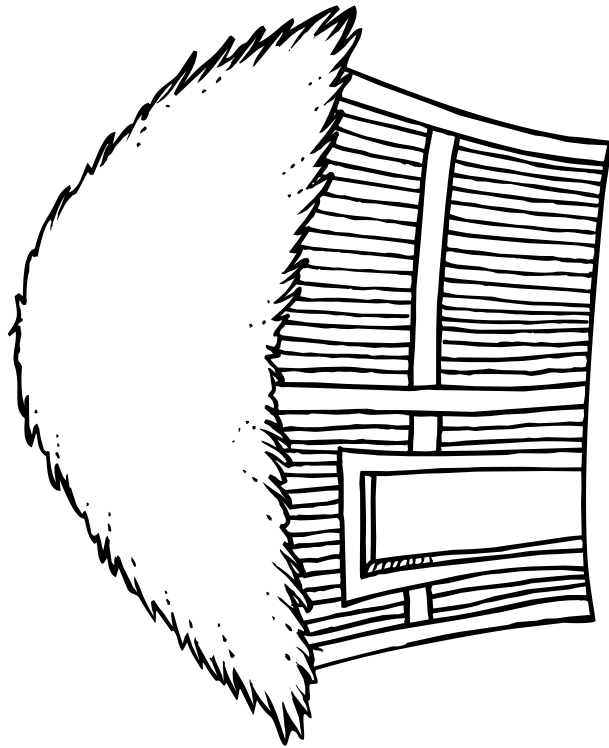

A lot of *n*uts on a *h*ut.

ed

 Trace the **ed** sound.

 Colour **Ted**.

 Trace the **ed** sounds in the sentence.

 Circle the **ed** sounds.

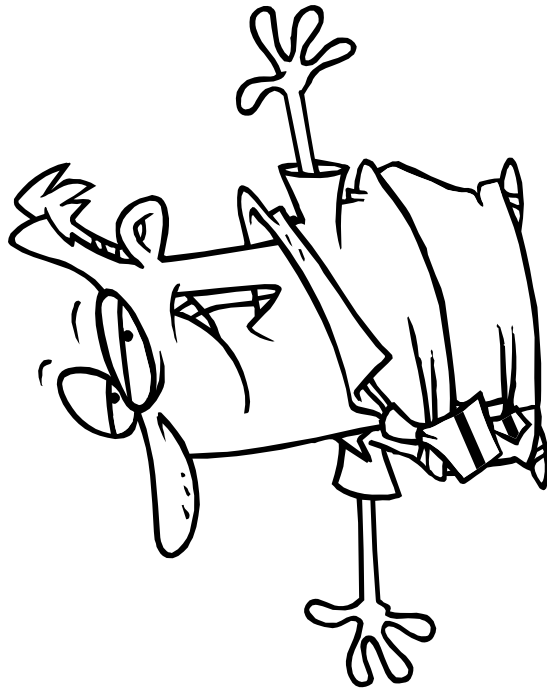

Lots of *beds* near *Ted*.

 Trace the **ed** words.

 Colour the beds.

 Cut them out and paste around Ted.

bed wed red fed
led

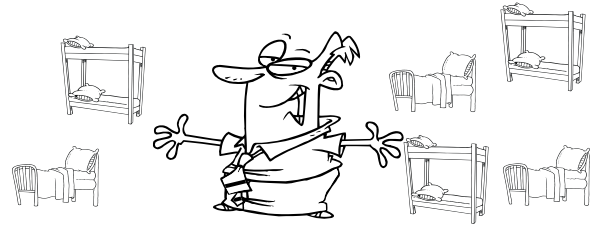

Lots of **beds** near Ted.

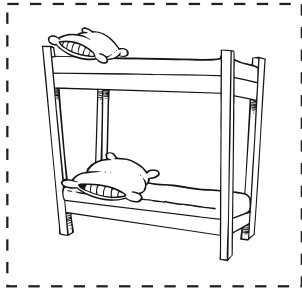

led

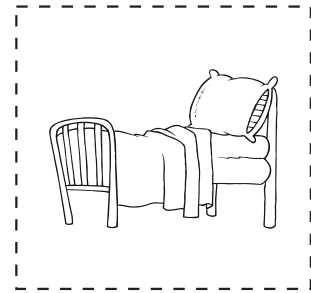

red

wed

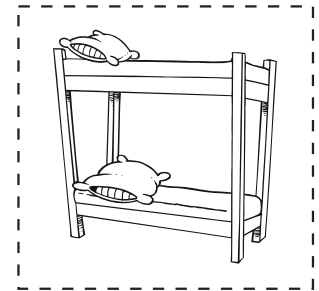

fed

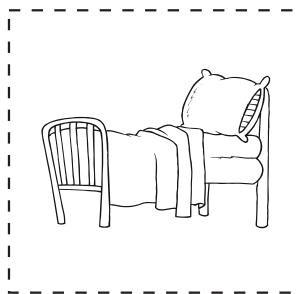

bed

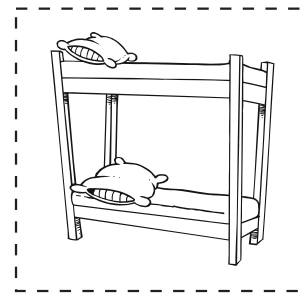
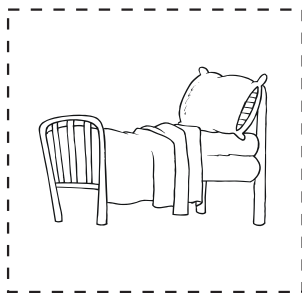

en

 Trace the **en** sound.

 Colour the pen.

 Trace the **en** sounds in the sentence.

 Circle the **en** sounds.

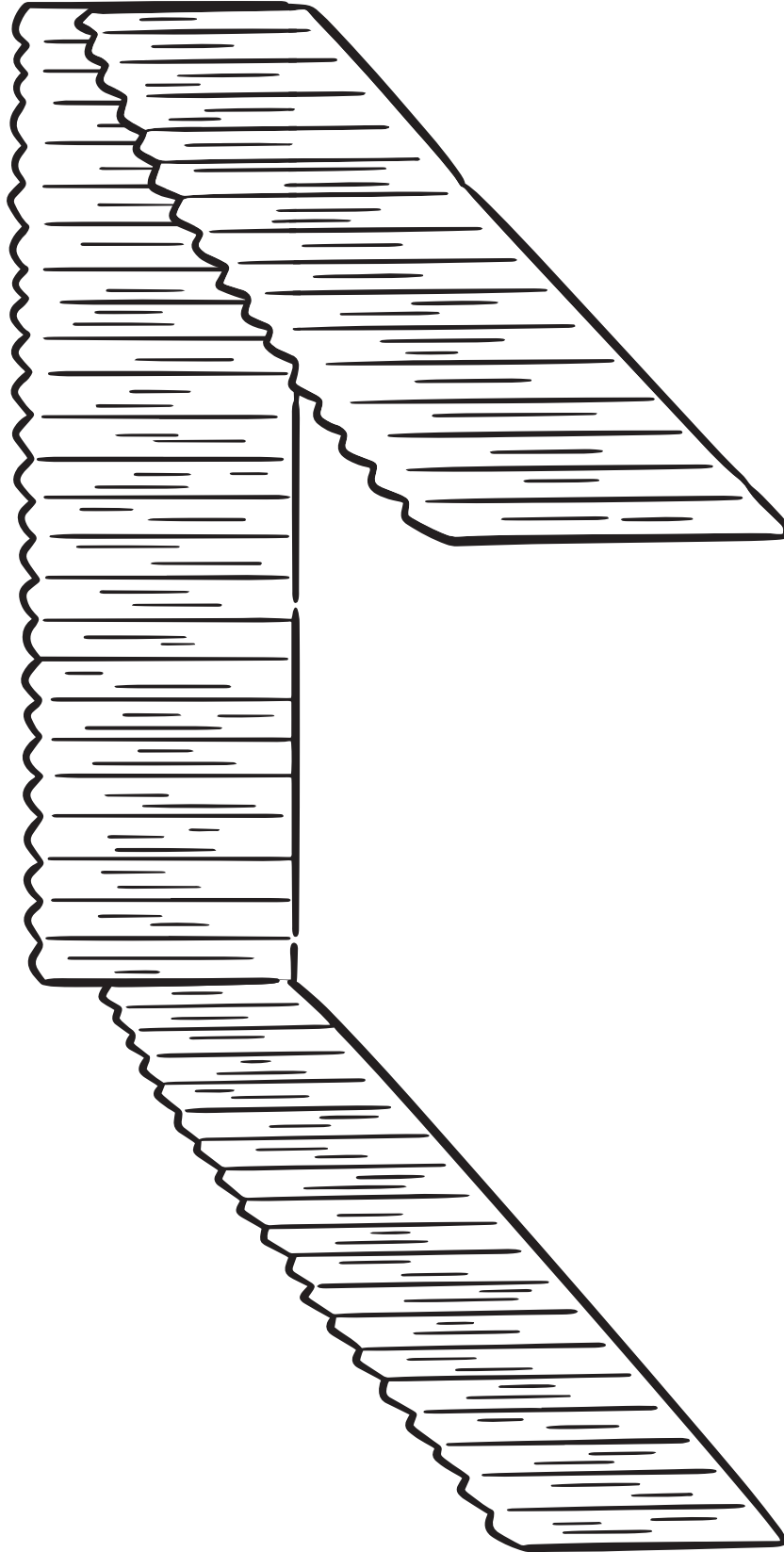

Hens in a pen.

 Trace the **en** words.

 Colour the hens.

 Cut them out and paste in and around the pen.

men ten pen
den Ben

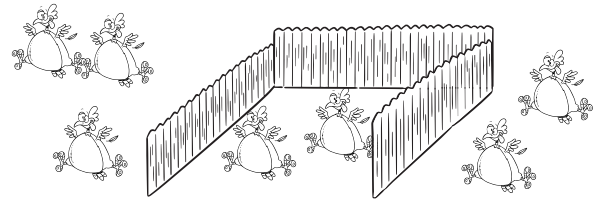

Hens in a pen.

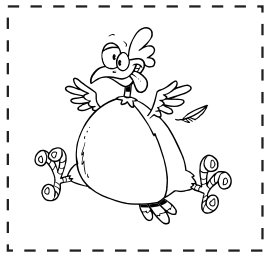

ten

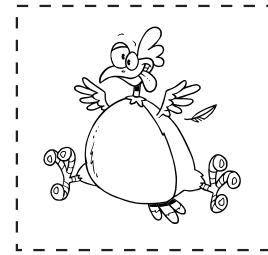

men

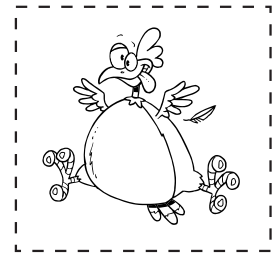
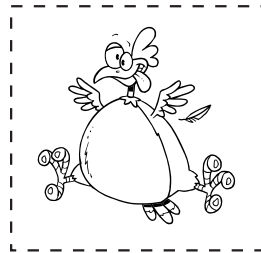

den

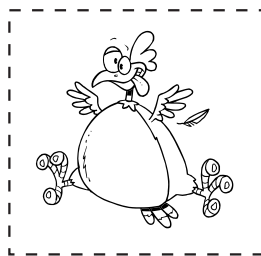

pen

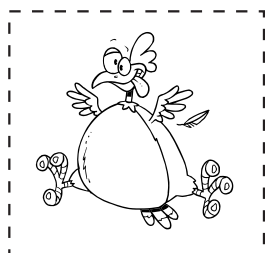

Ben

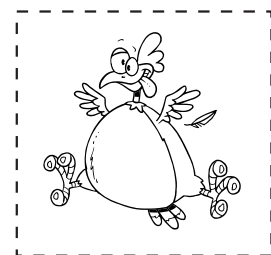

et

 Trace the **et** sound.

 Colour the vet.

 Trace the **et** sounds in the sentence.

 Circle the **et** sounds.



The vet has lots of pets.

 Trace the **et** words.

 Colour the pets.

 Cut them out and paste around the vet.



The vet has lots of pets.

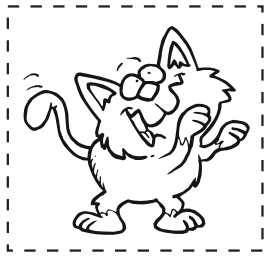

get

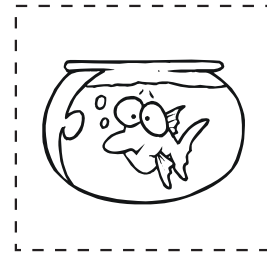

net

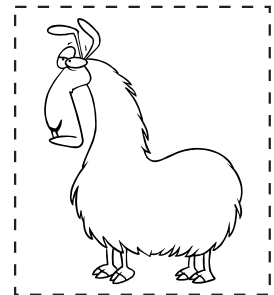
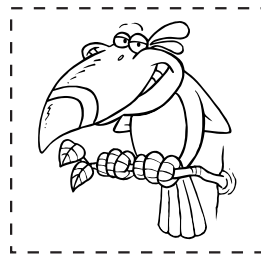

met

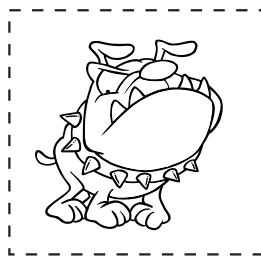

wet

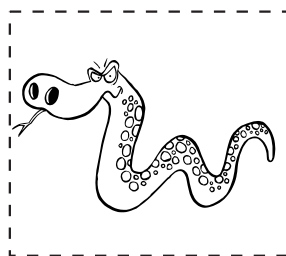

jet

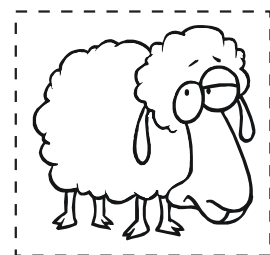

ab

cab tab
dab nab
jab
lab

ad

had lad
bad fad
sad pad
dad mad

ag

bag nag
rag gag
wag jag
tag lag
sag

am

jam yam
ham Sam
dam
ram

an

ban pan
can ran
fan Dan
van Nan
man tan

ap

cap nap
sap gap
lap map
tap yap
rap zap

at

cat sat
rat hat
mat pat
fat vat
bat

ax

tax sax
wax vax
fax lax
Max

ib

bib jib
nib
fib
rib

ig

did rid
hid bid
kid Sid
lid

im

rim him
Tim Jim
Kim vim
dim

in

bin kin
tin din
pin gin
fin sin
win

ip

lip dip
nip hip
sip kip
tip pip
zip

it

bit hit
kit sit
fit pit
lit
wit

ob

cob Bob
rob dob
sob fob
mob job
nob lob

od

cod sod
nod
pod
rod

og

dog cog
hog jog
bog log
fog

op

top hop
pop lop
cop sop
mop
bop

ot

hot pot
not dot
lot jot
got rot
cot tot

ub

rub cub
tub dub
hub pub
bub
sub

ug

bug mug
dug pug
hug rug
jug tug
lug

um

hum gum
mum yum
rum
sum

un

bun nun
sun pun
fun gun
run

ut

hut rut
cut mut
but jut
nut
gut

ed

bed wed
red Jed
fed Ned
led
Ted

eg

beg peg
leg Meg
keg

en

hen zen
pen ten
den Ben
men Ken
Jen yen

et

get vet
met yet
set pet
wet bet
let net

